



St Annes Bridge Club

Lytham St Annes



Opening One of a Suit Bidding Recap





- With a hand between 12 and 19 pts you open the bidding
- You can open with 11 if the hand meets the rule of 20
- If the hand is not suitable for 1 NT open one of a suit
- The suit must be your longest
- If 2 suits of equal length open the higher ranking
 - exception if 4 hearts and 4 spades bid one heart

Raising Partner's Suit (limit bids)

- If you have 6+pts and 4 of your partner's suit you respond
- If partner opens 1 of a major and you have 4 (or longer) support raise the suit as follows:
 - 6-9 points raise to the two level (single raise)
 - 10-12 points raise to the three level (double raise)
 - 13+ points raise to the four level (game raise)
- Take account of shape in your response (void=4pts, singleton=3pts, doubleton=1pt)
- Partner may 'ask a question' after your limit bid eg 1S-2S-3S





Taking account of shape as responder

Once you have found a fit with partner, shortages become valuable eg

	J 9 5
	A 10 7 3
	9 7 6
	K 5 3

Partner opens 1 H
You respond:

2 H

	J 9 6 5 4
	A 10 7 3
	6
	K 5 3

Partner opens 1 H
You respond:

3 H

Limit Bids

Once you have made a limit bid (eg 1 S – 2 S) partner is 'in charge'. Partner can 'ask a question' to help decide the final contract.

Eg.

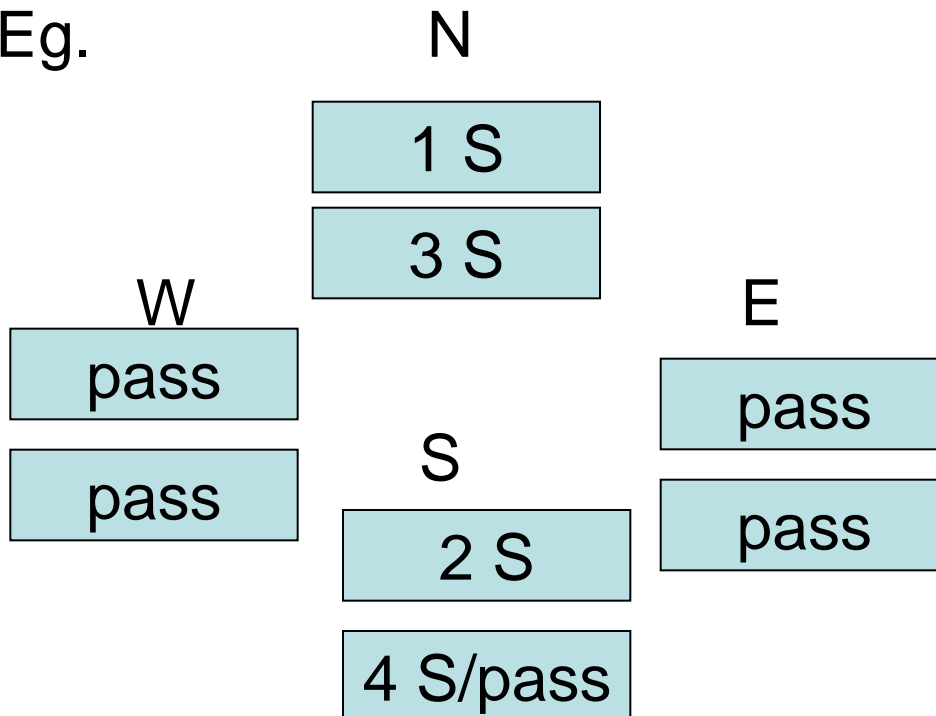

Hands

Board	Dealer
1	South
2	South
3	East
4	East
5	South
6	South
7	North
8	West
9	West
10	East
11	South
12	West

Homework!

- Read Pgs 34-36
- Memorise first 2 sections of page 44
‘what to open’ and ‘supporting partner’s suit’