



Egypt Take Both Titles

First & foremost, a big “Thank you” to all NBOs who did their best to successfully accomplish this first week of our Zonal Championship. We are also grateful to the TD Team led by Waleed, and to every local monitor, who, together, supervised the whole week’s encounters with such professionalism and dedication. Congratulations to **Egypt** Teams (Seniors and Mixed) for, not only qualifying to Marrakech but, also, for winning both titles of “African Champions” in a very convincing way for Egypt Seniors and thanks to 0,5 IMP carryover for Egypt Mixed. Congratulations to **South Africa** Seniors for qualifying to Marrakech. Last, but not least, welcome to a new squad from **Tunisia**, a Mixed Team, a blend of veterans and youngsters, who qualified their country for the World Championships next August. Hard luck to Reunion, Kenya and Morocco.

A special mention to the first three pairs in each category’ butler during the Round Robin phase:

Mixed

Nesrine Hamdy and Karim Nabil (Egypt) with 1,07 IMPs/Board (224 boards)

Farida Guerraoui and Ismail Chamar (Morocco) with 0,97 IMPs/board (144 boards)

Monya Klibi and Wissem Bellazreg (Tunisia) with 0,81 IMPs/Board (144 boards)

Seniors

Mokhtar El-Bassuni and Tarek Metwally (Egypt) with 1,02 IMPs/Board (112 boards)

Ayman Azzam and Adel El Kordy (Egypt) with 0,85 IMPs/Board (160 boards)

Brian Pincus and Diniar Minwalla (South Africa) with 0,74 IMPs/Board (144 boards)

Morocco Seniors and Mixed win the third place and reach the podium.

Good luck to both the Ladies Teams and the Open Teams who start their competition tomorrow. We are looking forward to some thrilling moments for the last two prestigious titles.

Bernard Pascal

Full Scores on following page





| African Bridge Federation | | | | | | |
|--|---------------------|------------|------------|------------|--------------|--------------|
| ABF Trials 2023 - Senior & Mixed Teams / Final & Play-off | | | | | | |
| May - 23 | | | | | | |
| Senior Final | | | S 1 | S 2 | Total | PEN. |
| | | | IMP | IMP | IMP | |
| 1 | EGYPT | 0.5 | 83 | 30 | 113.5 | 74.5 |
| | SOUTH AFRICA | 0 | 13 | 26 | 39.0 | -74.5 |
| Mixed Final | | | S 1 | S 2 | Total | PEN. |
| | | | IMP | IMP | IMP | |
| 1 | EGYPT | 0.5 | 35 | 28 | 63.5 | 0.5 |
| | TUNISIA | 0 | 46 | 17 | 63.0 | -0.5 |
| Mixed Play-off | | | S 1 | S 2 | Total | PEN. |
| | | | IMP | IMP | IMP | |
| 3 | SOUTH AFRICA | 0.5 | 27 | 38 | 65.5 | -3.5 |
| | MOROCCO | 0 | 43 | 26 | 69.0 | 3.5 |

The Three Missing Team Photos



Egypt Mixed Team From Top Dalia Hashem, Fatma Mandily, Nessrine Hamdy, Abdelrahman Mosaad, Mohamed Heshmat, Karim Nabil



Tunisia Mixed Team (L to R) Ismail Mostafa, Ahmed Zein, Adel El Kordy, Ayman Azzam, tarek Metwali, Mokhtar El Bassyouni



South Africa Senior Team (L to R) James Grant, Larry Chemaly, Diniar Minwalla, Maureen Narunsky, Michael Alexander, Brian Pincus





Some Team Photos



Morocco Senior and Mixed Teams: (Lto R) Ismail Chamar, Farida Elguerraoui, Abdallah Elhrari, Pierre Tkint, Noufissa Sebti, Ahmed Kacimi, Khalil Bensouda, Abderrahim Tazi, Roger Yans, Mohammed Dinia



Egypt Senior Team (L to R) Ismail Mostafa, Ahmed Zein, Adel El Kordy, Ayman Azzam, tarek Metwali, Mokhtar El Bassyouni



Reunion Mixed: (L to R) Denise Bauquier, Jean-Luc Neulat, Régine Wan Hoi, Michel Lemarinel, Narguis Huseinali, Christian Giraud



Reunion Seniors: (L to R) Patrice Dordhain, Jean-Marc Breslaw, Simon Philippe, Geneviève Vigna, Philippe Lagache, Patrick Hame



Kenya Mixed: (L to R) Aruna Shah, Samina Ismail, Bhanumati Shah, Chandrakant Shah, Saleem UD Deen, Jayantilal K Haria



South Africa Mixed: (L to R) Janne Masojada, Craig Gower, Rita Gawron, Lex van Vught, Joy Rothenberg, Tim Cop





Mixed Championship Semi-Final Session 3 South Africa v Tunisia

The third of four sessions of the semi-final in the Mixed Championships saw South Africa playing against Tunisia. Tunisia had had the better of the first two sessions and South Africa had to win this session to keep their hopes alive of reaching the final and going to Marrakesh.

Board 36. Dealer West. All Vul.

| | | |
|----------|--|---------|
| ♠ 864 | | |
| ♥ AKJ | | |
| ♦ J8 | | |
| ♣ 107653 | | |
| ♠ 109 | | ♠ AK753 |
| ♥ Q6 | | ♥ 1092 |
| ♦ K7652 | | ♦ A94 |
| ♣ AKJ4 | | ♣ 92 |
| | | ♠ QJ2 |
| | | ♥ 87543 |
| | | ♦ Q103 |
| | | ♣ Q8 |



Open Room

| West | North | East | South |
|----------------|--------------|----------------|---------------|
| <i>Farhani</i> | <i>Gower</i> | <i>Mestiri</i> | <i>Gawron</i> |
| 1♦ | Pass | 1♠ | Pass |
| 2♣ | Pass | 2♥ | Pass |
| 3♦ | Pass | 5♦ | All Pass |

There is no game available for East-West, perhaps East was a little precipitous in bidding game directly. I do not know if the 2♥ was game forcing if not then perhaps an invite to game might be better if 2♥ is game forcing then one could try an immediate 3♦ over 2♣. Declarer lost the top two hearts and could not avoid the loss of a trump for one off.

Closed Room

| West | North | East | South |
|-------------|------------|-----------------|---------------------|
| <i>Cope</i> | <i>Ali</i> | <i>Masojada</i> | <i>Hediasellami</i> |
| 1♦ | Pass | 1♠ | Pass |
| 2♣ | Pass | 3♦ | Pass |
| 3NT | All Pass | | |

North started with the king of hearts and saw the

♥3, showing an odd number according to their convention card, so North knows that South has three or five hearts. If three then declarer has hidden a four-card major – seems unlikely. So proudly bang down the ace of hearts and see declarer’s queen fall. However North was not sure or did not stop to work out the heart situation and so switched to a club and now declarer had plenty of time to establish the diamond suit and make his contract when the hearts were blocked. If North had cashed his three hearts and switched, say, to a spade then declarer should take his one chance and nonchalantly play a small diamond from table and hope that South is having a doze and plays small and now you can duck the trick into North’s hand and make your contract thanks to the club finesse. 12 IMPs to South Africa.

Board 46. Dealer East. None Vul.

| | | |
|----------|--|---------|
| ♠ 9852 | | |
| ♥ 6 | | |
| ♦ AJ7642 | | |
| ♣ 105 | | |
| ♠ 107 | | ♠ J3 |
| ♥ AQ9743 | | ♥ KJ52 |
| ♦ Q | | ♦ K93 |
| ♣ AJ92 | | ♣ 8643 |
| | | ♠ AKQ64 |
| | | ♥ 108 |
| | | ♦ 1085 |
| | | ♣ KQ7 |



Open Room

| West | North | East | South |
|----------------|--------------|----------------|---------------|
| <i>Farhani</i> | <i>Gower</i> | <i>Mestiri</i> | <i>Gawron</i> |
| - | - | Pass | 1♠ |
| 2♥ | 4♠ | All Pass | |

North’s prompt 4♠ kept the opposition quiet. On the lead of the queen of diamonds declarer won, drew trumps and established the diamonds, holding the defence to their two aces and a diamond trick.





12th African Bridge Championships



Closed Room

| West | North | East | South |
|-------------|------------|-----------------|---------------------|
| <i>Cope</i> | <i>Ali</i> | <i>Masojada</i> | <i>Hediasellami</i> |
| – | – | Pass | 1♠ |
| 2♥ | 3♠ | Pass | 4♠ |
| 5♣ | 5♦ | 5♥ | 5♠ |
| All Pass | | | |

There is a pleasing asymmetry on the last round of bidding, I do not recall seeing that happen before. West cashed his two aces before playing a second club. Declarer drew trumps in two rounds and then fell from grace by starting on the diamond suit by leading the ♦10 from hand. Now she had to lose two diamond tricks. It never gains leading the ten, it is *de rigueur* to start with a small one to cater for the singleton honour in West's hand. The extra undertrick only cost one point but it was 11 IMPs to South Africa

Board 47. Dealer South. N/S Vul.

| | | | | | |
|---------|---|--------|-----|---|------|
| ♠ 1097 | <table border="1"> <tr><td>N</td></tr> <tr><td>W E</td></tr> <tr><td>S</td></tr> </table> | N | W E | S | ♠ 64 |
| N | | | | | |
| W E | | | | | |
| S | | | | | |
| ♥ K82 | ♥ AQ9 | | | | |
| ♦ 10763 | ♦ K982 | | | | |
| ♣ Q93 | | ♣ 8762 | | | |
| | ♠ KQJ52 | | | | |
| | ♥ 10764 | | | | |
| | ♦ Q | | | | |
| | ♣ J54 | | | | |

Open Room

| West | North | East | South |
|----------------|--------------|----------------|---------------|
| <i>Farhani</i> | <i>Gower</i> | <i>Mestiri</i> | <i>Gawron</i> |
| – | – | – | Pass |
| Pass | 1NT | Pass | 2♣ |
| Pass | 2♦ | Pass | 3♠ |
| Pass | 4♠ | All Pass | |

A lot of players use the Smolen convention in this situation – they bid the shorter major at the three-level after a Two Diamonds response to rightside the declaration. Declarer won the opening diamond lead and cashed three rounds of trumps finishing in hand. A successful club finesse followed and the other club honours now cashed. All declarer needs to do now is to play hearts at every available opportunity, the defence will take their three heart tricks and your thirteenth will be your tenth trick. Unfortunately declarer ruffed a diamond and now all was lost. The defence cannot force you twice in diamonds without setting up a diamond trick for you, as West can only win one of the heart leads.

Closed Room

| West | North | East | South |
|-------------|------------|-----------------|---------------------|
| <i>Cope</i> | <i>Ali</i> | <i>Masojada</i> | <i>Hediasellami</i> |
| – | – | – | Pass |
| Pass | 1NT | Pass | 2♣ |
| Pass | 2♦ | Pass | 3♥ |
| Pass | 3♠ | Pass | 4♠ |
| All Pass | | | |

Indeed at this table the Smolen convention was being used as surmised above. Played by North the lead was a club won in hand with the ♣10. Declarer set about hearts immediately and had plenty of time to set up the thirteenth and so make his contract and gain 12 for Tunisia.

South Africa won the session 43-24 to cut the deficit to 42 and so keep South Africa hopes alive.





Mixed Championship Semi-Final Session 4 Egypt v Morocco

In the fourth and final stanza of the semi-final between South Africa and Tunisia, South Africa needed to overturn a lead of 42 IMPs. They would need some swingy deals and modicum of good fortune if things were to go their way.

Board 5. Dealer North. N/S Vul.

♠ J8
♥ J6532
♦ J954
♣ A9

♠ 54
♥ Q10
♦ 10872
♣ Q8632

♠ KQ76
♥ 87
♦ AKQ63
♣ 54

♠ A10932
♥ AK94
♦ —
♣ KJ107

W N
S E

Open Room

| West | North | East | South |
|----------------|--------------|----------------|---------------|
| <i>Farhani</i> | <i>Gower</i> | <i>Mestiri</i> | <i>Gawron</i> |
| – | Pass | 1NT | 2♣* |
| Pass | 3♥ | All Pass | |
| 2♣ | Majors | | |

Needing to push a bit I was surprised that South did not carry on to game. As twelve tricks are available it was no surprise that declarer succeeded in his contract.

Closed Room

| West | North | East | South |
|----------------|----------------|----------------|----------------|
| <i>ClosedW</i> | <i>ClosedN</i> | <i>ClosedE</i> | <i>ClosedS</i> |
| – | Pass | 1♦ | Double |
| 3♦ | 4♥ | All Pass | |

North was considerably more forward here and it paid dividends as he made eleven tricks easily and 11 IMPs.

Board 10. Dealer East. All Vul.

♠ 98532
♥ 742
♦ A6
♣ Q106

♠ K76
♥ 8
♦ KJ98743
♣ J8

♠ AQ10
♥ KQ
♦ Q1052
♣ 9742

♠ J4
♥ AJ109653
♦ —
♣ AK53

W N
S E

Open Room

| West | North | East | South |
|----------------|--------------|----------------|---------------|
| <i>Farhani</i> | <i>Gower</i> | <i>Mestiri</i> | <i>Gawron</i> |
| – | – | 1♦ | 1♥ |
| 2♥ | Pass | 3♦ | 3♥ |
| Pass | Pas | Double | Pass |
| 4♦ | All Pass | | |

If I had the South hand my opponents would not be playing at the four-level, they would need to get past me and my heart suit. Plus 100 is not much reward against a vulnerable game.

Closed Room

| West | North | East | South |
|----------------|----------------|----------------|----------------|
| <i>ClosedW</i> | <i>ClosedN</i> | <i>ClosedE</i> | <i>ClosedS</i> |
| – | – | 1♦ | 4♥ |
| 5♦ | Pass | Pass | Double |

At least at this table the Four Hearts bid forced the opposition to sacrifice at the five-level. The defence took their obvious four top tricks for +500 and 9 IMPs for Tunisia.

The boards were not conducive to creating swings and as South Africa pushed with low chance games the gap widened and in the end Tunisia won the match by a healthy margin.





ABF eyes in all venues

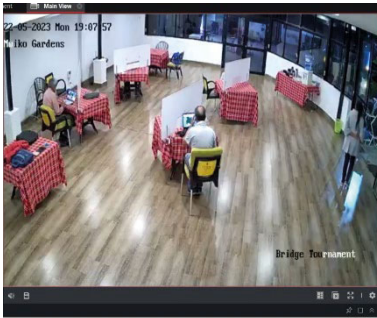

**Kenya venue,
Cam 1**

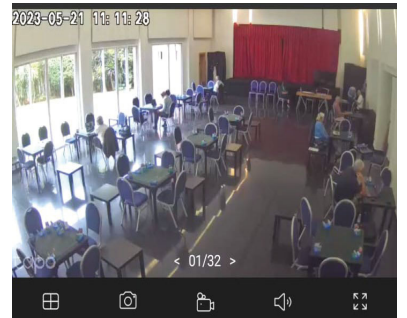

**Morocco venue,
Cam 1**

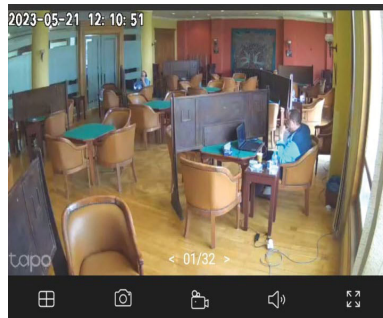

**Egypt venue,
Cam 1**

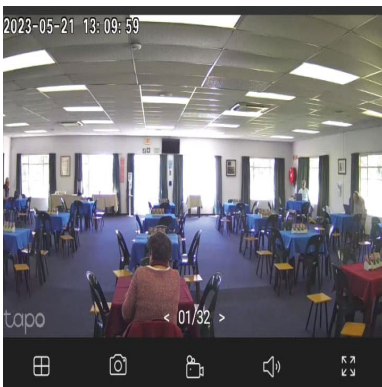

**South Africa-JHB
venue, Cam 1**

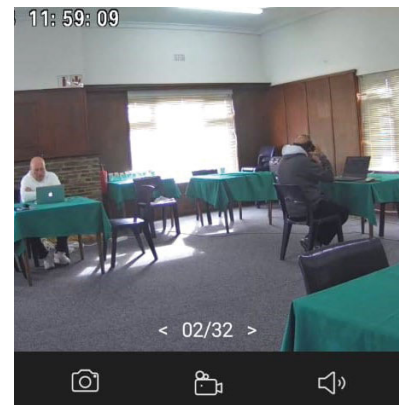

**South Africa-C.T
venue, Cam 1**

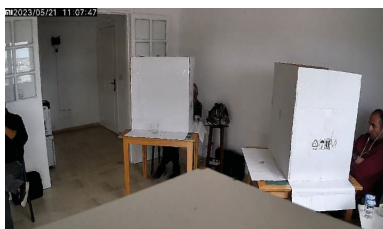

**Tunisia venue,
Cam 1**

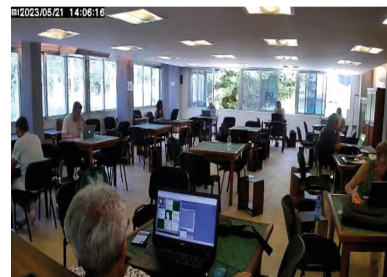

**Reunion venue,
Cam 1**





Final Session 1

The first set of boards for the finals saw a large number of swings, 18 double digit scores over the three sixteen board matches. We will start by examining boards five and seven as they caused a swing in all three matches.

The Seniors final is between Egypt and South Africa. The Mixed final sees Egypt facing Tunisia and the play-off is between South Africa and Morocco.

Board 5. Dealer North. N/S Vul.

| | | | | | |
|--------|---|---|-----|---|------|
| ♠ KJ42 | <table border="1"> <tr><td>N</td></tr> <tr><td>W E</td></tr> <tr><td>S</td></tr> </table> | N | W E | S | ♠ 96 |
| N | | | | | |
| W E | | | | | |
| S | | | | | |
| ♥ AK | ♥ Q72 | | | | |
| ♦ AQ8 | ♦ 5 | | | | |
| ♣ Q643 | ♣ AKJ10852 | | | | |
| | ♠ A 1073 | | | | |
| | ♥ 109854 | | | | |
| | ♦ J762 | | | | |
| | ♣ — | | | | |

Seniors Final

Open Room

| West | North | East | South |
|--------------|--------------|----------------|----------------|
| <i>Grant</i> | <i>Azzam</i> | <i>Chemaly</i> | <i>Elkordy</i> |
| – | Pass | 1♣ | Pass |
| 1♠ | Pass | 2♣ | Pass |
| 4♣* | Pass | 4♠ | Pass |
| 6♣ | All Pass | | |
| 4♣ | RKCB | | |

Not a bad slam, but how should you play it? There is no technical difference between playing on diamonds or spades but there can be a psychological one. I would have played a trump to hand at trick two and immediately led a spade to the king trying to give the appearance of sneaking a spade through, even if this loses they may well not try another spade and so give you the second chance of the diamond finesse. Here declarer tried the diamond finesse and so failed.

Closed Room

| West | North | East | South |
|----------------|---------------|-------------|-----------------|
| <i>Mostafa</i> | <i>Pincus</i> | <i>Zein</i> | <i>Minwalla</i> |
| – | Pass | 3♣ | Pass |
| 3NT | All Pass | | |

That's a mighty pre-empt and it gave West little choice but to bid the no-trump game and after a diamond lead he had twelve tricks, a slightly lucky let off to gain 11 IMPs for Egypt

Mixed Final

Open Room

| West | North | East | South |
|---------------------|--------------|------------|--------------|
| <i>Hediasellami</i> | <i>Nabil</i> | <i>Ali</i> | <i>Hamdy</i> |
| – | Pass | 3♣ | Pass |
| 3NT | All Pass | | |

Again a very meaty pre-empt and the same response from partner and the same diamond lead and the same twelve tricks, would they be lucky again?

Closed Room

| West | North | East | South |
|---------------|---------------|--------------------|--------------|
| <i>Hashem</i> | <i>Wissem</i> | <i>Abdelrahman</i> | <i>Klibi</i> |
| – | Pass | 3NT* | Pass |
| 4NT | Pass | 5♥ | Pass |
| 5NT | Pass | 6♣ | All Pass |
| 3NT | Solid minor | | |

The East hand does not fit my definition of a solid minor, nor any book definition either, but fortune, they say, favours the brave. Also it always quite pleasing when the suit is mentioned for the first time at the six-level. The cherry on the cake was the lead of the ace of spades, handing declarer twelve tricks on a plate. 10 IMPs to Egypt.

Mixed Play-off

Open Room

| West | North | East | South |
|-------------------|-------------------|-----------------|------------------|
| <i>Abderrahim</i> | <i>Rothenberg</i> | <i>Noufissa</i> | <i>van Vught</i> |
| – | Pass | 1♣ | Pass |
| 1♠ | Pass | 2♣ | Pass |
| 3♣ | All Pass | | |

What we have here is a fundamental difference of opinion as to what Three Clubs means. I cannot





say, I know that with at least one of my partners it is not forcing but it depends on your agreements. I am sure there is now a serious system discussion now in progress.

Closed Room

| West | North | East | South |
|-------------|------------------|-----------------|---------------|
| <i>Cope</i> | <i>Guerraoui</i> | <i>Masojada</i> | <i>Chamar</i> |
| - | Pass | 1♣ | Pass |
| 1♠ | Pass | 2♣ | Pass |
| 4♣* | Pass | 4♠ | Pass |
| 6♣ | All Pass | | |
| 4♣ | RKCB | | |

After a heart was led declarer played all but one of his trumps before playing a spade to the king to bring home the slam and 13 IMPs to South Africa

Board 7. Dealer South. All Vul.

| | | | | | | | | | | | |
|---------|---|---------|---|--|---|--|---|--|---|--|--|
| ♠ 974 | | ♠ J1083 | | | | | | | | | |
| ♥ K98 | | ♥ J5 | | | | | | | | | |
| ♦ A1092 | | ♦ Q754 | | | | | | | | | |
| ♣ AK9 | | ♣ Q108 | | | | | | | | | |
| ♠ Q52 | | | | | | | | | | | |
| ♥ 76432 | | | | | | | | | | | |
| ♦ 63 | | | | | | | | | | | |
| ♣ 764 | | | | | | | | | | | |
| | <table border="1" style="text-align: center; width: 40px; height: 40px;"> <tr><td></td><td>N</td><td></td></tr> <tr><td>W</td><td></td><td>E</td></tr> <tr><td></td><td>S</td><td></td></tr> </table> | | N | | W | | E | | S | | |
| | N | | | | | | | | | | |
| W | | E | | | | | | | | | |
| | S | | | | | | | | | | |
| | | ♠ AK6 | | | | | | | | | |
| | | ♥ AQ10 | | | | | | | | | |
| | | ♦ KJ8 | | | | | | | | | |
| | | ♣ J532 | | | | | | | | | |

Seniors Final

Open Room

| West | North | East | South |
|--------------|--------------|----------------|----------------|
| <i>Grant</i> | <i>Azzam</i> | <i>Chemaly</i> | <i>Elkordy</i> |
| - | - | - | 1♣ |
| Pass | 1♦ | Pass | 2NT |
| Pass | 6NT | All Pass | |

Declarer won the heart lead in hand and cashed the ace and king of clubs hoping for the queen to drop. The nine of diamonds ran round successfully and then another to the jack. The king of diamonds saw West discard a club so a small club now established the twelfth trick.

Closed Room

| West | North | East | South |
|----------------|----------------|-------------|-----------------|
| <i>Mostafa</i> | <i>Pincus</i> | <i>Zein</i> | <i>Minwalla</i> |
| - | - | - | 1NT |
| Pass | 3♣* | Pass | 3NT |
| All Pass | | | |
| 3♣ | Puppet Stayman | | |

Did South down grade his hand because of the shape or did he miscount, we shall never know but it meant North was not interested in slam and so they languished in game and lost 13 IMPs to Egypt.

Mixed Final

Open Room

| West | North | East | South |
|---------------------|--------------|------------|--------------|
| <i>Hediasellami</i> | <i>Nabil</i> | <i>Ali</i> | <i>Hamdy</i> |
| - | - | - | 1♣ |
| Pass | 1♦ | Pass | 2NT |
| Pass | 4NT | All Pass | |

South did not value his 4333 18 count any where near a maximum and so declined the invite to slam. To add insult to injury the lead of a diamond presented him with twelve tricks.

Closed Room

| West | North | East | South |
|---------------|---------------|--------------------|--------------|
| <i>Hashem</i> | <i>Wissem</i> | <i>Abdelrahman</i> | <i>Klibi</i> |
| - | - | - | 1♣ |
| Pass | 1♦ | Pass | 2NT |
| Pass | 6NT | All Pass | |

Yet again the lead was a heart taken in hand. The ace and king of clubs were cashed and a small led towards saw East take his queen. He exited with a spade. Declarer cashed the thirteenth club, a heart discard from West and a diamond from East. When the jack of diamonds from hand was not covered dummy's ace was played and the finesse taken successfully against East and now twelve trick were for the taking along with 13 IMPs for Tunisia.

Mixed Play-off

Open Room

| West | North | East | South |
|-------------------|-------------------|-----------------|------------------|
| <i>Abderrahim</i> | <i>Rothenberg</i> | <i>Noufissa</i> | <i>van Vught</i> |
| - | - | - | 1♣ |
| Pass | 3NT | Pass | 6NT |
| All Pass | | | |

Declarer misguessed the diamond position and so did not make his contract.

Closed Room

| West | North | East | South |
|-------------|------------------|-----------------|---------------|
| <i>Cope</i> | <i>Guerraoui</i> | <i>Masojada</i> | <i>Chamar</i> |
| - | - | - | 1♣ |
| Pass | 1♦ | Pass | 2NT |
| Pass | 4NT | All Pass | |

Again when North invites South will not progress.





13 IMPs to Morocco.

Boards 8 and 11 saw game swings in both the finals.

Board 8. Dealer West. None Vul.

| | | | | | | | | | | | |
|-----------|---|---------|---|--|---|--|---|--|---|--|--------|
| ♠ A | | ♠ KQ976 | | | | | | | | | |
| ♥ Q5 | | ♥ 76 | | | | | | | | | |
| ♦ AK10986 | | ♦ J7 | | | | | | | | | |
| ♣ QJ76 | | ♣ K952 | | | | | | | | | |
| ♠ J832 | <table border="1" style="text-align: center; width: 40px; height: 40px;"> <tr><td></td><td>N</td><td></td></tr> <tr><td>W</td><td></td><td>E</td></tr> <tr><td></td><td>S</td><td></td></tr> </table> | | N | | W | | E | | S | | ♠ 1054 |
| | | N | | | | | | | | | |
| W | | | E | | | | | | | | |
| | | S | | | | | | | | | |
| ♥ J943 | ♥ AK1082 | | | | | | | | | | |
| ♦ Q42 | ♦ 53 | | | | | | | | | | |
| ♣ A4 | | ♣ 1083 | | | | | | | | | |

Seniors Final

Open Room

| West | North | East | South |
|--------------|--------------|----------------|----------------|
| <i>Grant</i> | <i>Azzam</i> | <i>Chemaly</i> | <i>Elkordy</i> |
| Pass | 1♦ | 1♠ | Double |
| 2♠ | 4NT | Pass | 5♦ |
| All Pass | | | |

Declarer took the king of spades lead in his hand with the ace. He then made an apparently strange looking play of the ♥Q to the ace. A diamond to the ten and East's jack and the queen of spades played. Declarer ruffed, drew trumps and played a heart to the ♥10, if it had held and the hearts were 3-3 he would have brought home his contract but alas the jack was on the wrong side and so he was two off.

Closed Room

| West | North | East | South |
|----------------|---------------|-------------|-----------------|
| <i>Mostafa</i> | <i>Pincus</i> | <i>Zein</i> | <i>Minwalla</i> |
| Pass | 1♦ | 1♠ | Double |
| 3♠ | Double | Pass | 4♥ |
| All Pass | | | |

The spade lead was taken in dummy and then the jack of clubs which ran round to West's ace. Another spade was ruffed in dummy and a small club to the ♣10 which held the trick. Declarer's last spade was ruffed in dummy. The ace and king of diamonds and a third diamond ruffed and overruffed. The ace of trumps was cashed and now declarer needs to decide whether the remaining are 3-0 or 2-1, if the former he should exit with the club, if the latter he should cash the king. He chose the king but when he exited with a club West ruffed rather than

letting it run round to partner's ace. The upshot contract made and 11 IMPs to South Africa.

Mixed Final

Open Room

| West | North | East | South |
|---------------------|--------------|------------|--------------|
| <i>Hediasellami</i> | <i>Nabil</i> | <i>Ali</i> | <i>Hamdy</i> |
| Pass | 1♦ | 1♠ | 2♥ |
| 2♠ | 4♥ | All Pass | |

West's spade lead was won in dummy and the queen of clubs played, taken by West who returned the suit to her partner's ace. Another club was ruffed by West and now declarer could not make his contract as if he ruffed two spades in dummy he would set up a heart trick for the defence and if he established the diamonds he had no entry after drawing trumps.

Closed Room

| West | North | East | South |
|---------------|---------------|--------------------|--------------|
| <i>Hashem</i> | <i>Wissem</i> | <i>Abdelrahman</i> | <i>Klibi</i> |
| Pass | 1♦ | 1♠ | Double |
| 3♠ | 4♣ | Pass | 5♣ |
| Double | All Pass | | |

Not a fan of 4♣. After a spade lead declarer eventually lost control when the defence led spades at every available opportunity Three down. 10 IMPs to Egypt

Board 11. Dealer South. None Vul.

| | | | | | | | | | | | |
|----------|---|---------|---|--|---|--|---|--|---|--|-------|
| ♠ K985 | | ♠ QJ743 | | | | | | | | | |
| ♥ 86 | | ♥ 42 | | | | | | | | | |
| ♦ KQJ975 | | ♦ 8 | | | | | | | | | |
| ♣ 8 | | ♣ KQJ94 | | | | | | | | | |
| ♠ A6 | <table border="1" style="text-align: center; width: 40px; height: 40px;"> <tr><td></td><td>N</td><td></td></tr> <tr><td>W</td><td></td><td>E</td></tr> <tr><td></td><td>S</td><td></td></tr> </table> | | N | | W | | E | | S | | ♠ 102 |
| | | N | | | | | | | | | |
| W | | | E | | | | | | | | |
| | | S | | | | | | | | | |
| ♥ A10975 | ♥ KQJ3 | | | | | | | | | | |
| ♦ 102 | ♦ A643 | | | | | | | | | | |
| ♣ 10732 | | ♣ A65 | | | | | | | | | |

Seniors Final

Open Room

| West | North | East | South |
|--------------|--------------|----------------|----------------|
| <i>Grant</i> | <i>Azzam</i> | <i>Chemaly</i> | <i>Elkordy</i> |
| - | - | - | 1♦ |
| 1♥ | 2♥ | 2♠ | 3♦ |
| Pass | 3NT | All Pass | |

Once the defence started with clubs there was no





hope for declarer. The defence generously gave up one undertrick but the contract still failed

Closed Room

| West | North | East | South |
|----------------|---------------|-------------|-----------------|
| <i>Mostafa</i> | <i>Pincus</i> | <i>Zein</i> | <i>Minwalla</i> |
| - | - | - | 1♦ |
| 1♥ | Double | Pass | 1NT |
| Pass | 3♦ | Pass | 3NT |
| All Pass | | | |

You would not have kept me quiet on the East hand after partner made an overcall. When West led his suit South took this trick and quickly set up a ninth before the defence attacked clubs.

Mixed Final

Open Room

| West | North | East | South |
|---------------------|--------------|------------|--------------|
| <i>Hediasellami</i> | <i>Nabil</i> | <i>Ali</i> | <i>Hamdy</i> |
| - | - | - | 1♦ |
| 1♥ | Double | Redble | 1NT |
| 2♣ | 2♦ | 3♣ | 3♦ |
| Pass | 3♥ | Pass | 3NT |
| Pass | 5♦ | All Pass | |

The club lead was won in hand and another ruffed Trumps were drawn in two rounds and inexplicably declarer drew a third round. The jack of hearts was next and it held the trick. Then for reasons which escape me the ♠10 was run round to East's jack and now the defence cashed their two aces to take down a fairly solid contract.

Closed Room

| West | North | East | South |
|---------------|---------------|--------------------|--------------|
| <i>Hashem</i> | <i>Wissem</i> | <i>Abdelrahman</i> | <i>Klibi</i> |
| - | - | - | 1♦ |
| 1♥ | 1♠ | 2♣ | Pass |
| 3♣ | 5♦ | All Pass | |

Again a club was led and won in hand. Declarer played simply but accurately by taking two rounds of trumps and leading a heart to the king whereupon West took his ace and exited with a heart. Declarer now took his chance and led towards the king of spades and when the ace was onside he had eleven tricks and ten IMPs for Tunisia.





Your Chief Tournament Director Waleed El Menyawi explains the important procedures to be observed during the Championships:

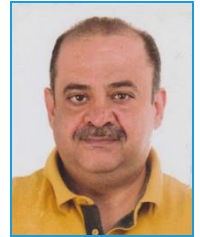

Play Links

Each category will have its own playing link (Open teams link – Women teams link .. etc. Play links will be posted to the captains' WhatsApp group and will be also posted to the ABF website at the following link

https://www.bridgewebs.com/cgi-bin/bwop/bw.cgi?club=abf&pid=display_page24

Click the Match number, official start time or Session open time of your category to join the game. The game will be open to players 30 min before the official start time.

1. Open, Women & Mixed Categories.

For the Semi-final, Final and play-off sessions, It has been decided that:

- The team ranked higher after the RR stage will be the Home team in sessions 2 and 4 in the Semi-final match.
- The team ranked lower after the RR stage will be the Home team in sessions 1 and 3 in the Semi-Final match.
- The team ranked higher after the RR stage will be the Home team in session 2 in the Final or Play-off match.
- If Morocco team qualify to the final match in any category, there will be a 4 Segments play-off match between the semi-final losers to determine the team to qualify to Marrakesh.

2. All Africa Pairs tie-break procedure

If two pairs or more have the same cumulative score after the end of the 2nd session or 4th Session, the tie shall be broken as follows:

- A. The pair with the higher score in the 2nd / 4th session shall determine the final ranking.
- B. Mutual boards between the tied pairs - if applicable -

3. Teams Events ... Last RR

The last Round Robin for all categories shall be done according to the final ranking of the teams in the previous played rounds.

4. Click the link below for instructions

[Alert Procedures - Undo Procedures - General Instructions](#)

5. Play instructions and Schedule of play ...

- A. When you log on to the RealBridge game (using the game link), you will find your team name written in one of the Tables.
- B. All team members are required **to sit at their table (all together)** in Pairs NS and EW, later on, when we start the session, the software will automatically move the EW pairs between the tables according to the schedule of play.





that the process had not been followed properly in some material way, the Reviewer will ask the Head TD to correct the failings and issue a new ruling.

8. Time delay and hesitation

- It is very important to know that the TDs have the tools to produce a board report which includes the time for each bid / play by each player, so please be bare that in mind when calling the TD for a possible hesitation or before denying it.

- It is also very important to know that the TDs also have the tools to produce a session time report which includes the exact time taken by each player in a session, in case of time delay, the penalty will be given according to this report.

9. Home & Visiting teams

- When you log in to the RealBridge game (using the game link), you will find your team name written on one of the Tables.
- All team members are required to sit at their table (all together) in Pairs NS and EW, later on, when we start the session, the software will automatically move the EW pairs between the tables according to the schedule of play.
- In the schedule of play you will find Home team (the team mentioned first) and Visiting team (the team mentioned second)
- NO LINE-UP will be needed from the teams, the visiting team has to sit first at their table (in Pairs NS and EW), minimum 10 min before the official start time, and the Home team has the right to have a look at the visiting team and sit its pairs accordingly.

10. Headphones / Earphones

In order to minimize the noise in the venue as much as possible...

- It is mandatory for each player to have his own headphone / earphone which is connected to his device during play
- Use the table chat / private chat as much as possible and don't use vocal chat.
- Any vocal explanation will not be taken into the TD consideration in any case.
- You need to be very careful when using the table chat as you might give an unauthorized information to your partner which could results in adjusted score by the TD.

11. Kibitzers

- Kibitzers are not allowed by any means at 1) the playing venue, 2) RealBridge online playing room.
- All players are required to immediately leave the playing area when they finish their session, players are also kindly asked to keep their seats and not roam around the playing area.
- All the matches will be broadcasted via RealBridge kibitzer website...

<https://kibitz.realbridge.online/>





determined a slightly different ruling would not be good reason for the ruling to be varied. In the event that the process had not been followed properly in some material way, the Reviewer will ask the Head TD to correct the failings and issue a new ruling.

8. Time delay and hesitation

- It is very important to know that the TDs have the tools to produce a board report which includes the time for each bid / play by each player, so please be bare that in mind when calling the TD for a possible hesitation or before denying it.
- It is also very important to know that the TDs also have the tools to produce a session time report which includes the exact time taken by each player in a session, in case of time delay, the penalty will be given according to this report.

9. Home & Visiting teams

- When you log in to the RealBridge game (using the game link), you will find your team name written on one of the Tables.
- All team members are required to sit at their table (all together) in Pairs NS and EW, later on, when we start the session, the software will automatically move the EW pairs between the tables according to the schedule of play.
- In the schedule of play you will find Home team (the team mentioned first) and Visiting team (the team mentioned second)
- NO LINE-UP will be needed from the teams, the visiting team has to sit first at their table (in Pairs NS and EW), minimum 10 min before the official start time, and the Home team has the right to have a look at the visiting team and sit its pairs accordingly.

10. Headphones / Earphones

In order to minimize the noise in the venue as much as possible...

- It is mandatory for each player to have his own headphone / earphone which is connected to his device during play
- Use the table chat / private chat as much as possible and don't use vocal chat.
- Any vocal explanation will not be taken into the TD consideration in any case.
- You need to be very careful when using the table chat as you might give an unauthorized information to your partner which could results in adjusted score by the TD.

11. Kibitzers

- Kibitzers are not allowed by any means at 1) the playing venue, 2) RealBridge online playing room.
- All players are required to immediately leave the playing area when they finish their session, players are also kindly asked to keep their seats and not roam around the playing area.
- All the matches will be broadcasted via RealBridge kibitzer website...

<https://kibitz.realbridge.online/>





- At the RealBridge kibitzer website, you can find the live broadcasted matches and also all the other matches scheduled for broadcast.
- For security reasons, all broadcasted matches will be delayed by 30-45 min.

12. Smoking, Eating and Alcohol, Mobile and electronic devices

We must act as if we were playing these championships "live", therefore, the following is strictly forbidden during play:

- Mobile phones and any other electronic devices, Mobile phones will be collected and there will be a regular check each session by the monitor.
- Eating (even if only biscuits)
- Drinking Alcohol
- Smoking
- Going to the WC without permission
- Talking loudly during or at the end of any board if the player is unhappy about his/her partner's bid, hand play or defense.

46th WORLD BRIDGE TEAMS CHAMPIONSHIPS 13th WORLD TRANSNATIONAL OPEN TEAMS Marrakech, Morocco • 20 August - 2 September 2023* **Registration and Opening Ceremony on 19 August*





Roster - Open Teams

Egypt

| |
|------------------|
| Captain |
| Ahmed Zayed |
| Wael Adel |
| Raafat El Sayyad |
| Ahmed Hussein |
| Motaz Fouada |
| Sherif Noshy |
| Moaz Hammam |

Kenya

| |
|--------------------|
| Captain |
| Bhanumati Shah |
| Samina Ismail |
| Ramula Shah |
| Samina Esmail |
| Saleem Ud Deen |
| Aruna Shah |
| Chandrakant V Shah |

Morocco

| |
|-----------------------|
| Captain |
| Fatim Lahlou |
| Mohammed Adnane Ammor |
| Ismail Chamar |
| Stephane Dahan |
| Fatim Lahlou |
| Pierre Sibony |
| |

Reunion

| |
|------------------|
| Captain |
| Patrick Hamel |
| Patrick Hamel |
| Christian Giraud |
| Gabriel Melin |
| Jean-Luc Neulat |
| Catherine Aouate |
| Régine Wan Hoi |

South Africa

| |
|-----------------|
| Captain |
| Hennie Fick |
| Neville Eber |
| Hennie Fick |
| Alon Apteker |
| Craig Gower |
| Bernard Donde |
| Robert Stephens |

Tunisia

| |
|-------------------------|
| Captain |
| Hassouna Ben Abdelmalek |
| Skander Touil |
| Ahmed Meddeb |
| Anis Ghodhbane |
| Mohamed Ali Lakhdhar |
| Omar Meddeb |
| Lassad Jedidi |





12th African Bridge Championships



GMT TIME

Open Teams Schedule of play

Each Match = 16 Boards in 2H 15min

| R.R (01) | | Match (01), 09H00 | | | | Match (02), 12H30 | | | | Match (03), 15H15 | | | |
|-----------|-----------|-------------------|---|---------------|-------------|---------------------------|---------------|-------------|---|--------------------------|-------------|---|---------------|
| Date | Table No. | Home Team | X | Visiting Team | Home Team | X | Visiting Team | Home Team | X | Visiting Team | Home Team | X | Visiting Team |
| 28 | 1 | 1 EGY | x | 6 KEN | 5 REU | x | 1 EGY | 1 EGY | x | 4 TUN | 1 EGY | x | 4 TUN |
| | 2 | 2 RSA | x | 5 REU | 6 KEN | x | 4 TUN | 5 REU | x | 3 MOR | 5 REU | x | 3 MOR |
| | 3 | 3 MOR | x | 4 TUN | 2 RSA | x | 3 MOR | 6 KEN | x | 2 RSA | 6 KEN | x | 2 RSA |
| R.R (01) | | Match (04), 09H00 | | | | Match (05), 12H30 | | | | RR(02) Match (01), 15H15 | | | |
| Date | Table No. | Home Team | X | Visiting Team | Home Team | X | Visiting Team | Home Team | X | Visiting Team | Home Team | X | Visiting Team |
| 29 | 1 | 3 MOR | x | 1 EGY | 1 EGY | x | 2 RSA | 6 KEN | x | 1 EGY | 6 KEN | x | 1 EGY |
| | 2 | 4 TUN | x | 2 RSA | 3 MOR | x | 6 KEN | 5 REU | x | 2 RSA | 5 REU | x | 2 RSA |
| | 3 | 5 REU | x | 6 KEN | 4 TUN | x | 5 REU | 4 TUN | x | 3 MOR | 4 TUN | x | 3 MOR |
| R.R (02) | | Match (02), 09H00 | | | | Match (03), 12H30 | | | | Match (04), 15H15 | | | |
| Date | Table No. | Home Team | X | Visiting Team | Home Team | X | Visiting Team | Home Team | X | Visiting Team | Home Team | X | Visiting Team |
| 30 | 1 | 1 EGY | x | 5 REU | 4 TUN | x | 1 EGY | 1 EGY | x | 3 MOR | 1 EGY | x | 3 MOR |
| | 2 | 4 TUN | x | 6 KEN | 3 MOR | x | 5 REU | 2 RSA | x | 4 TUN | 2 RSA | x | 4 TUN |
| | 3 | 3 MOR | x | 2 RSA | 2 RSA | x | 6 KEN | 6 KEN | x | 5 REU | 6 KEN | x | 5 REU |
| R.R (03) | | Match (05), 09H00 | | | | RR(03), Match (01), 12H30 | | | | Match (02), 15H15 | | | |
| Date | Table No. | Home Team | X | Visiting Team | Home Team | X | Visiting Team | Home Team | X | Visiting Team | Home Team | X | Visiting Team |
| 31 | 1 | 2 RSA | x | 1 EGY | 1 Team R 01 | x | 6 Team R 06 | 5 Team R 05 | x | 1 Team R 01 | 5 Team R 05 | x | 1 Team R 01 |
| | 2 | 6 KEN | x | 3 MOR | 2 Team R 02 | x | 5 Team R 05 | 6 Team R 06 | x | 4 Team R 04 | 6 Team R 06 | x | 4 Team R 04 |
| | 3 | 5 REU | x | 4 TUN | 3 Team R 03 | x | 4 Team R 04 | 2 Team R 02 | x | 3 Team R 03 | 2 Team R 02 | x | 3 Team R 03 |
| R.R (03) | | Match (03), 09H00 | | | | Match (04), 12H30 | | | | Match (05), 15H15 | | | |
| Date | Table No. | Home Team | X | Visiting Team | Home Team | X | Visiting Team | Home Team | X | Visiting Team | Home Team | X | Visiting Team |
| 01 | 1 | 1 Team R 01 | x | 4 Team R 04 | 3 Team R 03 | x | 1 Team R 01 | 1 Team R 01 | x | 2 Team R 02 | 1 Team R 01 | x | 2 Team R 02 |
| | 2 | 5 Team R 05 | x | 3 Team R 03 | 4 Team R 04 | x | 2 Team R 02 | 3 Team R 03 | x | 6 Team R 06 | 3 Team R 03 | x | 6 Team R 06 |
| | 3 | 6 Team R 06 | x | 2 Team R 02 | 5 Team R 05 | x | 6 Team R 06 | 4 Team R 04 | x | 5 Team R 05 | 4 Team R 04 | x | 5 Team R 05 |

The Semi-final and Final schedule on Friday 2nd and Saturday 3rd of June will be published later.





Roster - Women Teams

Egypt

Captain

Dina El Awady

Nada Wattar

Catherine Pascal

Hoda Soliman

Hoda Soliman

Marguerite Homsy

Nada Moussa

Kenya

Captain

Bijal Shah

Bijal Shah

Punam Shah

Samira Dedhia Soni

Rupal shah

Sejal Shah

Vimla Virjee

Morocco

Captain

Hayat Hachimi

Hayat Hachimi

Leila Kabbaj

Samira Teber

Grazellia Nabil

Leila Benmlih

Khadija Marrakchi

South Africa

Captain

Roz Bernstein

Roz Bernstein

Sharon Lang

Vanessa Armstrong

Carol Stanton

Nicky Bateman

Tas Nestoridis

Tunisia

Captain

Mohamed Rebai

Ferdaous Trabelsi

Maissa Farhani

Hedia Sellami

Jalila Ghodhbane

Meriem Daldoul

Aicha Daldoul





12th African Bridge Championships



GMT TIME

Women Teams Schedule of play

Each Match = 16 Boards in 2H 15min

| R.R (01) | | Match (01), 09H00 | | | | Match (02), 12H30 | | | | Match (03), 15H15 | | | |
|-------------------------|-----------|-------------------|---|---------------|-------------|---------------------------|---------------|-------------|---|--------------------------|-------------|---|---------------|
| Date | Table No. | Home Team | X | Visiting Team | Home Team | X | Visiting Team | Home Team | X | Visiting Team | Home Team | X | Visiting Team |
| SUN 28 | 1 | 1 EGY | x | 6 BYE | 5 KEN | x | 1 EGY | 1 EGY | x | 4 TUN | 6 BYE | x | 2 RSA |
| | 2 | 2 RSA | x | 5 KEN | 6 BYE | x | 4 TUN | 5 KEN | x | 3 MOR | 5 KEN | x | 2 RSA |
| | 3 | 3 MOR | x | 4 TUN | 2 RSA | x | 3 MOR | 6 BYE | x | 2 RSA | 6 BYE | x | 2 RSA |
| R.R (01) | | Match (04), 09H00 | | | | Match (05), 12H30 | | | | RR(02) Match (01), 15H15 | | | |
| Date | Table No. | Home Team | X | Visiting Team | Home Team | X | Visiting Team | Home Team | X | Visiting Team | Home Team | X | Visiting Team |
| MON 29 | 1 | 3 MOR | x | 1 EGY | 1 EGY | x | 2 RSA | 6 BYE | x | 1 EGY | 6 BYE | x | 1 EGY |
| | 2 | 4 TUN | x | 2 RSA | 3 MOR | x | 6 BYE | 5 KEN | x | 2 RSA | 5 KEN | x | 2 RSA |
| | 3 | 5 KEN | x | 6 BYE | 4 TUN | x | 5 KEN | 4 TUN | x | 3 MOR | 4 TUN | x | 3 MOR |
| R.R (02) | | Match (02), 09H00 | | | | Match (03), 12H30 | | | | Match (04), 15H15 | | | |
| Date | Table No. | Home Team | X | Visiting Team | Home Team | X | Visiting Team | Home Team | X | Visiting Team | Home Team | X | Visiting Team |
| TUE 30 | 1 | 1 EGY | x | 5 KEN | 4 TUN | x | 1 EGY | 1 EGY | x | 3 MOR | 1 EGY | x | 3 MOR |
| | 2 | 4 TUN | x | 6 BYE | 3 MOR | x | 5 KEN | 2 RSA | x | 4 TUN | 2 RSA | x | 4 TUN |
| | 3 | 3 MOR | x | 2 RSA | 2 RSA | x | 6 BYE | 6 BYE | x | 5 KEN | 6 BYE | x | 5 KEN |
| R.R (03) | | Match (05), 09H00 | | | | RR(03), Match (01), 12H30 | | | | Match (02), 15H15 | | | |
| Date | Table No. | Home Team | X | Visiting Team | Home Team | X | Visiting Team | Home Team | X | Visiting Team | Home Team | X | Visiting Team |
| WED 31 | 1 | 2 RSA | x | 1 EGY | 1 Team R 01 | x | 6 Team R 06 | 5 Team R 05 | x | 1 Team R 01 | 5 Team R 05 | x | 1 Team R 01 |
| | 2 | 6 BYE | x | 3 MOR | 2 Team R 02 | x | 5 Team R 05 | 6 Team R 06 | x | 4 Team R 04 | 6 Team R 06 | x | 4 Team R 04 |
| | 3 | 5 KEN | x | 4 TUN | 3 Team R 03 | x | 4 Team R 04 | 2 Team R 02 | x | 3 Team R 03 | 2 Team R 02 | x | 3 Team R 03 |
| R.R (03) | | Match (03), 09H00 | | | | Match (04), 12H30 | | | | Match (05), 15H15 | | | |
| Date | Table No. | Home Team | X | Visiting Team | Home Team | X | Visiting Team | Home Team | X | Visiting Team | Home Team | X | Visiting Team |
| THU 01 | 1 | 1 Team R 01 | x | 4 Team R 04 | 3 Team R 03 | x | 1 Team R 01 | 1 Team R 01 | x | 2 Team R 02 | 1 Team R 01 | x | 2 Team R 02 |
| | 2 | 5 Team R 05 | x | 3 Team R 03 | 4 Team R 04 | x | 2 Team R 02 | 3 Team R 03 | x | 6 Team R 06 | 3 Team R 03 | x | 6 Team R 06 |
| | 3 | 6 Team R 06 | x | 2 Team R 02 | 5 Team R 05 | x | 6 Team R 06 | 4 Team R 04 | x | 5 Team R 05 | 4 Team R 04 | x | 5 Team R 05 |

The Semi-final and Final schedule on Friday 2nd and Saturday 3rd of June will be published later.





RealBridge Playing Instructions

First : Log in , Lobby, at the table and Settings

1. To join any RealBridge game you will need a **LINK**

2. All the play links will be available on ABF website

https://www.bridgewebs.com/cgi-bin/bwop/bw.cgi?club=abf&pid=display_page24

AND you might also receive it by mail.

3. Click the link and you will be redirected to the log on page of our game which looks like the next figure ...

Notice that your video should appear in the right bottom corner of the page and mic volume showing that it works.

4. If you can't see your video then you need to allow your browser to use your cam and mic, do as follows to allow it

5. From Goggle Chrome and just before the address bar, press the lock icon

6. Allow cam and allow mic.

7. Write your name in the required field and press login – nothing else is to be done- **NO ID number will be used, (leave it blank)**

8. When you logged in you will see the lobby which almost looks like the following figure (**but this figure includes extra buttons for TDs**)

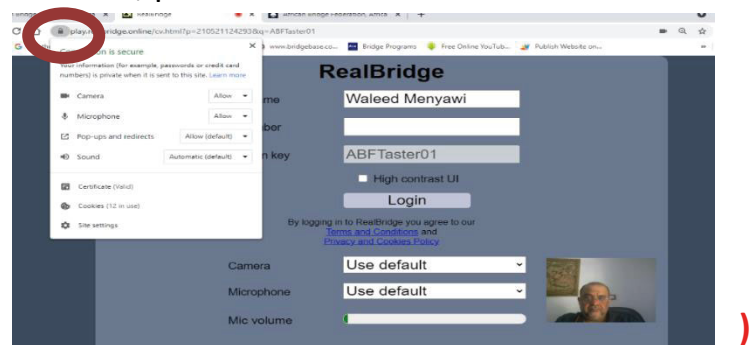
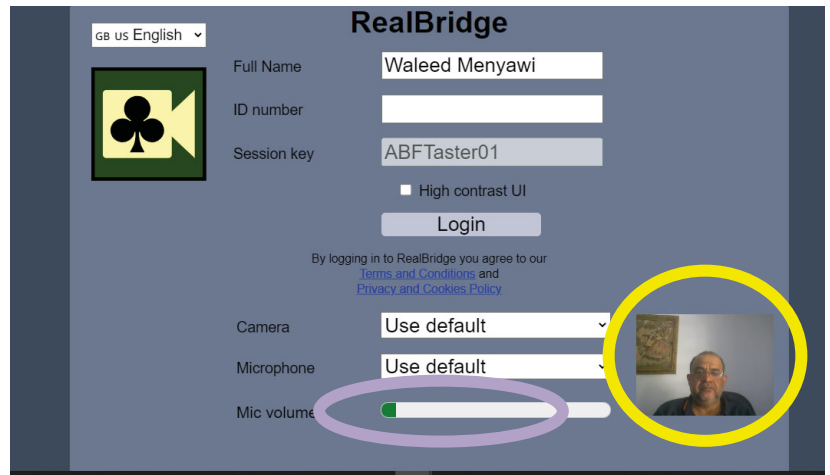

Notice the lobby chat window to the right.

**Keep an eye to the Lobby chat
- For important announcements**





9. Each table labeled with a team name, find your table and chose where to sit (Sit N, Sit S, Sit E or Sit W)

10. Get familiar with the buttons at your table and call the TD using the button for help.

Volume control for your partner.

Volume control for left-hand opponent. You have a separate volume control for each player. This only affects what you hear.

Private chat with left-hand opponent. You can chat privately only with the opponents, not partner

Volume control for right-hand opponent.

Private chat with right-hand opponent.

Disable/enable your video.

Disable / enable your microphone. Use this when you're on the phone!

Hide / unhide the other players' videos. Use this if you have a poor connection.

Redial. Restarts audio and video connections. Use it if the connection fails, or if your video or audio gets out of sync.

Settings

Display style

- Detailed cards
- Simplified cards

Deal animation

Slide

Animation duration

[Slider]

As defender, see dummy

- Facing declarer
- Facing me

As declarer, see dummy as

- Vertical suits (facing declarer)
- Horizontal hand

Input style

- One click or tap
- Two taps (tablet)
- Double click (mouse)

OK Cancel

"Detailed cards" shows pictures of cards; "Simplified cards" are schematic and have larger symbols

The orientation of dummy's cards when you are defending.

The orientation of dummy's cards when you are declaring.

Choose the way you make bids and plays. With "Two taps", the first tap selects the card, then the second tap confirms. "Double click" means that you make two fast clicks.

This controls how a new hand arrives at the beginning of each deal. Choose an effect, or set to "None" to have the hand simply appear.

If you have an animation enabled, use the slider to control how long the animation lasts.





11. After we play all boards

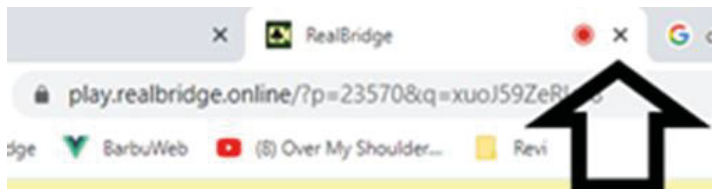

Leave RealBridge, close the tab. See the small X? just click it.



12. Can Use and Can't use

| Can Use | Can't use |
|---|---|
| <ul style="list-style-type: none"> • Windows laptop • Windows desktop • MacBook or another Apple laptop • iMac or another Apple desktop • Chromebook | <ul style="list-style-type: none"> • Smartphone • Old iPads, older than 2018. |

You must use one of these web browsers (you probably are using one of them!):

| Can Use ü | Can't use û |
|--|--|
| <p>Edge, Chrome, Firefox, Safari. The logo must look like one of these – exactly as below. If it looks different, you are using an out-of-date version. <i><u>If you are choosing amongst your browsers, we advise that you chose something other than Firefox.</u></i></p> | <p>Internet Explorer (notice the gold band) The old EDGE (see shape of the e)</p> |
|  |  |

Second : Bidding, Play, Alert and System

13. **At the start** of any session, All the team members are required to be seated at the same table (Table with the **team name label**), the system will automatically move the EW pairs to the opponents table when we start the session **and will send them back to their home table when both tables finish playing the boards.**

14. **Private chat and Table chat**

- It is strongly recommended to use the chat rather than the vocal chat; the TDs will not take into consideration any vocal explanation if you have any case.
- I will show you now, 2 figures and will appoint to you where to find the table chat (where the 4 players can see your chat) and where to find the private chat where you can chat privately with one of your opponents (not your partner of-course 😊).



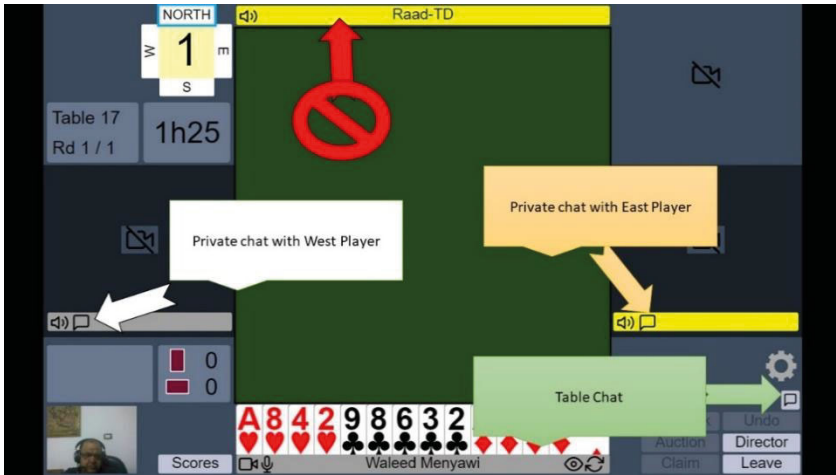

When you are at Full Screen mode

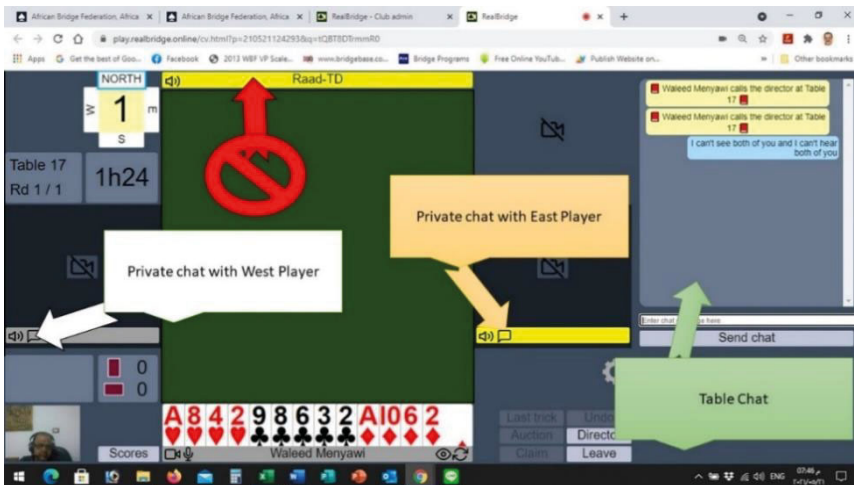

When you are at normal view (NOT Full Screen mode

15. Self-alert and self-explanation proper procedure:

1. Click alert (if required)
2. Write / Put in explanation
3. Make bid

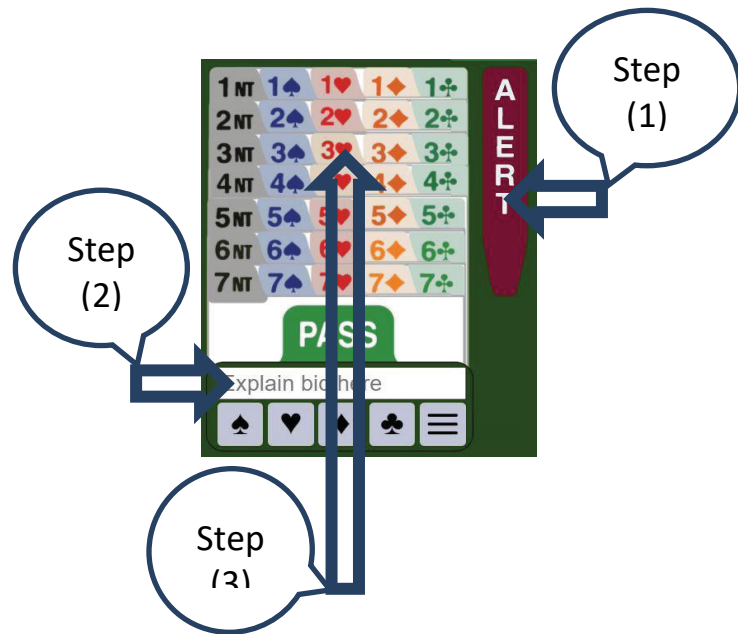



If you make a **mistake** or need to **explain your bid further** after you have bid, you can click on the bid and add more text.

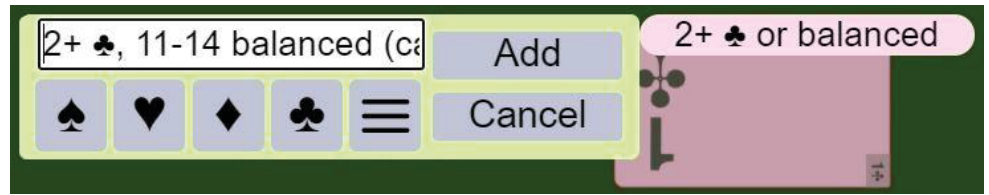

The added text will appear after an asterisk *. The time in seconds between when the bid was **made** and the added explanation was **submitted** is presented after the added text in the square brackets, for this example, 26 seconds. The character limit on explanations is 200 characters.

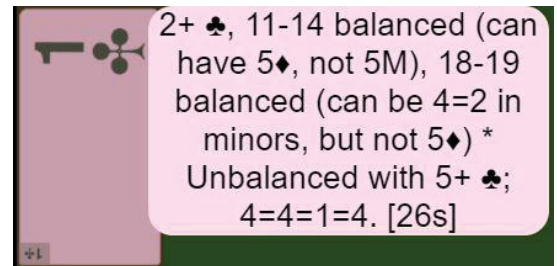

16. System

All teams are required to write a brief about their system at the table chat box before the start of first board in each match.

