



The Finals to Decide Champions of Africa

There is still one stanza of the Mixed Championships semi-finals to play. After three sessions Egypt took a near insurmountable lead against Morocco who graciously conceded. South Africa had a bad first session against Tunisia and lost a little more ground in the second but fought back in the third session to give them a chance in the fourth and final session tomorrow. The final session will start at 9.00 GMT. The Championship final will be between Egypt and the other semi-final winner,

In the Seniors Championship Egypt completed the Round Robin by a margin of more than two matches over South Africa who did the same to Morocco. So the Championship final will be between Egypt and South Africa.

The two finals will be over two sessions, the first starting at 12.30 GMT. In the Mixed Championships there will also be a play-off for third place, the two losing semi-finalists will fight it out, also over two sessions starting at 12.30.

African Bridge Federation

ABF Trials 2023 - Mixed Teams / Semi-Final

		May - 23						
G	Team		S 1	S 2	S 3	S 4	Total	PEN.
			IMP	IMP	IMP	IMP	IMP	
1	EGYPT	0.5	<u>67</u>	<u>70</u>	<u>66</u>		203.5	165.5
	MOROCCO	0	<u>20</u>	<u>9</u>	<u>9</u>		38.0	-165.5
G	Team		S 1	S 2	S 3	S 4	Total	PEN.
			IMP	IMP	IMP	IMP	IMP	
1	SOUTH AFRICA	0.5	<u>16</u>	<u>13</u>	<u>43</u>		72.5	-41.5
	TUNISIA	0	<u>62</u>	<u>28</u>	<u>24</u>		114.0	41.5





Seniors Teams Current Standings

African Bridge Federation

ABF Trials 2023 - Senior Teams

Click the session score to see match details

RR 6	Team		Previous RRs		S. 01		S. 02		S. 03		Total		PEN.	R
			IMP	V'P	IMP	V'P	IMP	V'P	IMP	V'P	IMP	V'P		
	Egypt	EGY	224	201.31	-10	7.20	27	16.26	47	18.87	338	243.64		1
	South Africa	RSA	83	168.47	10	12.80	-32	2.97	7	12.03	68	196.27		2
	Morocco	MOR	-161	121.00	18	14.60	32	17.03	-47	1.13	-158	153.76		3
	Reunion	REU	-196	103.72	-18	5.40	-27	3.74	-7	7.97	-248	120.83		4

African Bridge Federation

Cumulative butler ranking

Seniors & Mixed RRs

R	Contry / Category	PLAYER NAMES	ToT		Session 01		Session 02		Session 03		Session 04		Session 05			
			ToT	Bds	Score	Bds	Score	Bds	Score	Bds	Score	Bds	Score	Bds		
1	EGY (Mixed)	Nesrine Hamdy & Karim Nabil	1.07	224	0.69	32	0.3	48	1.66	48	1.72	16	0.8	32	1.25	48
2	EGY (Seniors)	Mokhtar El-bassuni & Tarek Metwally	1.02	112	2.64	16	-0.51	16	2.04	16			0.47	32	0.47	32
3	MOR (Mixed)	farida guerraoui & Ismail Chamar	0.97	144	1.77	16	1.19	32	2.04	32	0.82	16	-0.58	16	0.57	32
4	EGY (Seniors)	Azzam & Adel Elkordy	0.85	160	1.7	32	-0.19	32	0.93	32	-0.19	16	0.69	16	2.13	32
5	TUN (Mixed)	Wissem & monya Klibi	0.81	144	1.82	16	-0.84	32	-0.59	32	1.03	16	2.26	16	1.18	32
6	RSA (Seniors)	Brian Pincus & Diniar Minwalla	0.74	144	0.64	16	1.8	32	0.74	32	0.92	16	0.03	16	0.29	32
7	RSA (Mixed)	Craig Gower & Rita Gawron	0.62	144	2.12	16	0.73	32	-0.23	32	0.58	16	0.08	16	0.42	32
8	TUN (Mixed)	hediasellami & LAKHDHAR MOHAMED ALI	0.54	160	-0.84	32	0.24	32	2.35	32			0.25	32	0.72	32
9	EGY (Mixed)	Dalia hashem & Abdelrahman	0.48	128	-3.05	16	1.43	32	-0.02	32			1.93	16	2.11	32
10	MOR (Mixed)	Cambournac Guy* & chantal cambournac	0.39	144	0.9	16	0.56	32	0.09	32	1.6	16	0.06	16	-0.86	32
11	RSA (Mixed)	Janne Masojada & Tim Cope	0.22	160	0.64	32	-0.35	32	-0.06	32	-0.13	16	0.85	16	0.34	32
12	EGY (Seniors)	Ahmed Zein & Ismail Mostafa	0.16	144	-0.49	16	0.65	32	-0.06	32	-0.92	16	0.4	16	1.39	32
13	REU (Mixed)	narguis huseinali & Christian Giraud	0.13	96					0.19	32	-0.58	16	1.53	16	-0.63	32
14	RSA (Seniors)	Larry Chemaly & James Grant	0.09	144	1.21	16	-0.61	32	0.25	32	0.19	16	-0.31	16	-0.17	32
15	RSA (Mixed)	Lex van Vught & Joy Rothenberg	0.06	144	0.15	16	-0.23	32	0.58	32			-0.32	32	0.14	32
16	MOR (Seniors)	dinia mohammed & Belkouch Abdellatif	-0.1	112	-2.41	16	-0.04	32	0.38	32	0.85	16	0.72	16		
17	MOR (Seniors)	el ghrari & kacimi	-0.12	160	-0.85	32	0.59	32	0.19	32			-0.24	32	-0.28	32
18	REU (Seniors)	Philippe SIMON & patrick HAMEL	-0.17	160	1.3	32	0.5	32	-0.39	32	-1.39	16	-0.03	16	-1.025	32
19	REU (Mixed)	Denise Bauquier & JEAN LUC NEULAT	-0.24	192	-0.92	32	-0.56	48	0.95	48			0.92	32	-1.59	32
20	KEN (Mixed)	jimmy deen & samina esmail	-0.31	144	0.94	32	-0.41	32	-0.43	32			-1.53	16	-0.11	32
21	TUN (Mixed)	Mayssa Farhani & Anas MESTIRI	-0.31	144	-0.92	16	-0.17	32	-0.49	32	-1.72	16	0.75	16	0.68	32
22	RSA (Seniors)	Maureen Narunsky & michael alexander	-0.45	160	-1.06	32	0.24	32	0.31	32			-0.59	32	-1.15	32
23	KEN (Mixed)	Bhanumati Shah & jayanti haria	-0.48	160			0.99	32	-0.02	32	-0.82	16	-1.81	32	-0.72	48
24	MOR (Seniors)	t kint de roodenbeke catherine & pierre t kint	-0.51	112	-1.21	16	0.63	32	-2.66	32	1.39	16	-0.69	16		
25	REU (Seniors)	Patrice DORDHAIN & Jean Marc BRESLAW	-0.55	144	-0.99	16	-0.6	32	-0.96	32			0.03	32	-0.22	32
26	REU (Mixed)	WAN HOI REGINE & LEMARINEL Michel	-0.65	192	-0.88	32	-0.61	48	-1.24	48	0.13	16	0.71	16	-2	32
27	EGY (Mixed)	fatma manadily & mohamed heshmat	-0.69	96	0.75	16	-0.35	16	-1.74	16	-1.03	16	-0.85	16	-0.91	16
28	REU (Seniors)	VIGNA & LAGACHE	-0.92	144	-0.64	16	-2.45	32	-1.49	32	-0.85	16	-0.14	16	0.06	32
29	KEN (Mixed)	CHANDRAKANT Velji Shah & Aruna Shah	-1.03	144	0.58	32	-1.98	32	-0.37	32	-1.6	16	-1.93	16	-0.85	16
30	MOR (Mixed)	sebti noufissa & TAZI ABDERRAHIM	-1.05	160	-1.97	32	0.32	32	-1.21	32			-1.49	32	-0.88	32
31	MOR (Seniors)	dinia mohammed & khalil bensouda	-0.64	32					0.01						-1.28	32
32	MOR (Seniors)	el ghrari & pierre t kint	-0.53	16											-0.53	16
33	MOR (Seniors)	khalil bensouda & pierre t kint	-0.64	16											-0.64	16





Some Team Photos



Morocco Senior and Mixed Teams: (Lto R) Ismail Chamar, Farida Elguerraoui, Abdallah Elhrari, Pierre Tkint, Noufissa Sebti, Ahmed Kacimi, Khalil Bensouda, Abderrahim Tazi, Roger Yans, Mohammed Dinia



Egypt Senior Team (L to R) Ismail Mostafa, Ahmed Zein, Adel El Kordy, Ayman Azzam, tarek Metwali, Mokhtar El Bassyouni



Reunion Mixed: (L to R) Denise Bauquier, Jean-Luc Neulat, Régine Wan Hoi, Michel Lemarinel, Narguis Huseinali, Christian Giraud



Reunion Seniors: (L to R) Patrice Dordhain, Jean-Marc Breslaw, Simon Philippe, Geneviève Vigna, Philippe Lagache, Patrick Hame



Kenya Mixed: (L to R) Aruna Shah, Samina Ismail, Bhanumati Shah, Chandrakant Shah, Saleem UD Deen, Jayantilal K Haria



South Africa Mixed: (L to R) Janne Masojada, Craig Gower, Rita Gawron, Lex van Vught, Joy Rothenberg, Tim Cop





Mixed Championship Day 5 Session 3 South Africa v Morocco

Tunisia won their last match by 12.29 VPs and with Egypt scoring a clean sweep, South Africa needed not to lose by more than two points to be second in the table. South Africa had Morocco, the current fourth-placed team as their opponents.

Board 34. Dealer East. N/S Vul.

♠ 9		♠ KQ1082
♥ A2		♥ QJ98
♦ KJ10843		♦ —
♣ KQ42		♣ AJ107
		♠ 65
		♥ K1065
		♦ Q62
		♣ 9853
		♠ AJ43
		♥ 743
		♦ A975
		♣ 6

Open Room

West	North	East	South
<i>Abderrahim</i>	<i>Gower</i>	<i>Noufissa</i>	<i>Gawron</i>
—	—	Pass	1♠
2♦	4♦*	Pass	4♠
4NT	5♣	Pass	5♠
All Pass			

The problem with opening light is that sometimes you do not get the chance to let partner know that is what you have done and they will battle on in the belief you have a real hand. Admittedly declarer was slightly unlucky in that the defence found their heart ruff and beat the contract. but equally had South's diamond ace been the heart ace then there would have been a play for slam.

Closed Room

West	North	East	South
<i>Rothenberg</i>	<i>Guerraoui</i>	<i>Van Vught</i>	<i>Chamar</i>
—	—	Pass	Pass
1♦	1♠	Double*	4♠
All Pass			

East's Double was explained as negative, perhaps an exaggeration. The par contract was reached and made. A simple 13 IMPs to Morocco.

Board 35. Dealer South. E/W Vul.

♠ 843		♠ A10762
♥ 10872		♥ AK
♦ 104		♦ 2
♣ J963		♣ 107542
♠ KQ5		♠ J9
♥ QJ94		♥ 653
♦ AJ93		♦ KQ8765
♣ AK		♣ Q8

Open Room

West	North	East	South
<i>Abderrahim</i>	<i>Gower</i>	<i>Noufissa</i>	<i>Gawron</i>
—	—	—	2♦*
Double	3♦	4♣	Pass
4♥	Pass	4♠	Pass
4NT	Pass	5♣	Pass
	6♥	All Pass	

2♦ weak Natural

An apparent case of partnership misunderstanding. West believed 4♦ showed both majors, East did not. I suspect West was so intent on fulminating against partner's bid that he completely took his eye off the contract as he won the opening diamond lead and then ruffed one setting up a trump loser. He can still get home as North does not have another diamond to cash after taking his trump trick. Declarer has virtually no other play for the contract than North holding the four trumps, not unlikely after the weak two bid.





12th African Bridge Championships



Closed Room

West	North	East	South
<i>Rothenberg</i>	<i>Guerraoui</i>	<i>Van Vught</i>	<i>Chamar</i>
-	-	-	Pass
2NT	Pass	3♥	Pass
3♠	Pass	4♣	
4♦	Pass	4NT	Pass
5♦	Pass	6NT	

Solid bidding to a solid contract – twelve top tricks, contract made 17 IMPs to South Africa. Note Seven Spades can be made by ruffing three diamonds in dummy on a non-club lead, but it can also be made on a club lead – it is interesting to work out how.

Board 36. Dealer West. All Vul.

♠ AQ9853								
♥ -								
♦ 104								
♣ A10952								
♠ J74	<table border="1" style="display: inline-table; vertical-align: middle;"><tr><td>N</td><td></td></tr><tr><td>W</td><td>E</td></tr><tr><td></td><td>S</td></tr></table>	N		W	E		S	♠ K1062
N								
W	E							
	S							
♥ 84		♥ 52						
♦ AQ5		♦ J8762						
♣ Q7643		♣ K8						
♠ -								
♥ AKQJ109763								
♦ K93								
♣ J								

Open Room

West	North	East	South
<i>Abderrahim</i>	<i>Gower</i>	<i>Noufissa</i>	<i>Gawron</i>
Pass	1♠	Pass	2♥
Pass	2♠	Pass	3♥
Pass	3♠	Pass	4♥

All Pass

South bordered on timid, when the Great Shuffler gives you nine tricks and your partner opens you might be a touch more aggressive, but it looks as though the right thing has been done as in spite of partner having two aces the slam does not succeed as the ace of diamonds is offside. Indeed eleven tricks were easily taken.

Closed Room

West	North	East	South
<i>Rothenberg</i>	<i>Guerraoui</i>	<i>Van Vught</i>	<i>Chamar</i>
Pass	1♠	Pass	2♥
Pass	2♠	Pass	3♥
Pass	4♣	Pass	4NT
Pass	5♥	Pass	6♥

All Pass

A more forceful South battled on to the 50% slam, but in fact it is more than 50% because there is a significant chance that if the ace is offside then it might be led which is what happened at this table allowing declarer to claim at trick two. 13 IMPs to Morocco.

Board 38. Dealer East. E/W Vul.

♠ AQ107								
♥ QJ63								
♦ 87								
♣ QJ2								
♠ J865	<table border="1" style="display: inline-table; vertical-align: middle;"><tr><td>N</td><td></td></tr><tr><td>W</td><td>E</td></tr><tr><td></td><td>S</td></tr></table>	N		W	E		S	♠ 4
N								
W	E							
	S							
♥ K1085		♥ 97						
♦ Q1-4		♦ 9532						
♣ K3		♣ A109864						
♠ K932								
♥ A42								
♦ AKJ6								
♣ 75								

Open Room

West	North	East	South
<i>Abderrahim</i>	<i>Gower</i>	<i>Noufissa</i>	<i>Gawron</i>
-	-	Pass	1NT
Pass	2♣	Pass	2♠
Pass	4♠	All Pass	

West made the attacking lead of the king of clubs and when it held the trick played another for partner's ace. The club return was ruffed and West chose to exit with a heart, probably because partner led the ♣10 for the ruff, now declarer was in with a chance as she can ruff out the queen of diamonds which is what she did, but it required careful timing but declarer was up to the task.

Closed Room

West	North	East	South
<i>Rothenberg</i>	<i>Guerraoui</i>	<i>Van Vught</i>	<i>Chamar</i>
-	-	Pass	1NT
Pass	2♣	Pass	2♠
Pass	4♠	All Pass	

Unsurprisingly the same auction as the Open Room. The same first two tricks but to the third trick East led the ♣6 and West could read this for neither a high card nor a low card and so exited with a trump, Now there was no way for declarer to avoid the loss a trick in one of the red suits. 10 IMPs to South Africa.

At the end of a high scoring match with many part-scores swings South Africa held on to draw and so pipped Tunisia for the second place by a mere 0.74 VPs.





Mixed Championship Semi-Final Session 1 Egypt v Morocco

The first session of the semi-final in the Mixed Championship featured Egypt against Morocco.

Board 1. Dealer North, Non Vul.

♠ J10932		♠ K76
♥ 4		♥ Q76
♦ 7		♦ Q10854
♣ 1098764		♣ A2
♠ Q4		♠ A85
♥ 109852		♥ AKJ3
♦ J93		♦ AK52
♣ J53		♦ KQ

	N	
W		E
	S	

Open Room

West	North	East	South
<i>Guerraoui</i>	<i>Hashem</i>	<i>Chamar</i>	<i>Abdelrahman</i>
–	Pass	Pass	2♣
Pass	2♦	Pass	2NT
Pass	3♥	Pass	3♠
4♦	Pass	4♥	Pass
4♠	All Pass		

The correct contract nicely reached – the 3♠ bid guaranteed a spade fit. The club was taken by the ace and the suit returned for declarer’s queen. Declarer cashed his four red suit winners and ruffed a heart and could safely ruff a club to hand. Now a diamond ruff and dummy’s last club was ruffed with the ace and now declarer could not be prevented from taking a trick with his remaining trumps and so claimed his contract.

Closed Room

West	North	East	South
<i>Hamdy</i>	<i>C Cambournac</i>	<i>Nabil</i>	<i>G Cambournac</i>
–	Pass	1♦	Double
Pass	1♠	Pass	3NT
All Pass			

I would have been tempted with the North hand to try Four Clubs or Four Spades over 3NT. It is a hopeless contract and finished three light. 11 IMPs

to Egypt.

Board 5. Dealer North. N/S Vul.

♠ 97		♠ AK6
♥ Q5		♥ J43
♦ AK9853		♦ Q642
♣ A103		♣ Q86
♠ 532		♠ QJ1084
♥ K109862		♥ A7
♦ 10		♦ J7
♣ J74		♣ K952

	N	
W		E
	S	

Open Room

West	North	East	South
<i>Guerraoui</i>	<i>Hashem</i>	<i>Chamar</i>	<i>Abdelrahman</i>
–	1♦	Pass	1♠
Pass	2♦	Pass	3♣*
Pass	3♦	Pass	3NT
All Pass			
3♣	Game forcing		

The ten of hearts is led and dummy’s queen holds the first trick. It now comes down to how to play the diamonds for five tricks. If they are 3-2 then anything will work so we must consider the 4-1 splits. The absolute best is to play a top diamond and then lead the jack towards dummy, but that requires two entries to dummy and you have only one. Playing small towards the jack wins against singleton ten or queen in East and any singleton except the queen in the West. You could also play the seven and that is the same as the jack except it loses to the singleton 10. Both are the same and cater for 60% of the 4-1 breaks. Playing A and K succeeds 40% of the 4-1 splits. The third possibility is to lead towards dummy. Leading the jack succeeds against singleton Q or 10 in West and any singleton in East except the queen, you can start with the 7 and has the same chances losing out to the ten rather than the queen, so this is 60% as well, so as long as you do not bang out the A & K you have an advantage. Of the four best methods one loses on





the current layout and you can be sure that was the one declarer chose. Bad luck. Two down

Closed Room

West	North	East	South
Hamdy	C Cambournac	Nabil	G Cambournac
-	1♦	Pass	1♠
Pass	2♦	Pass	2NT
Pass	3NT	All Pass	

Same lead but here declarer applied the brute force method of cashing the ace and king of diamonds and so was fortunate to gain 14 IMPs for Morocco

Board 7. Dealer South. All Vul.

♠ 8	♠ AQ10932	♠ KJ76
♥ KJ87	♥ 2	♥ Q10653
♦ Q84	♦ J973	♦ AK102
♣ AKQ32	♣ J7	♣ -

♠ 54	♠ N	♠ A7
♥ A94	♠ W	♥ 864
♦ 65	♠ E	♦ 98642
♣ 1098654	♠ S	♣ 976

Open Room

West	North	East	South
Guerraoui	Hashem	Chamar	Abdelrahman
-	-	-	Pass
1♣	2♠	3♥	Pass
3♠	Double	3NT	Pass
4♥	Pass	5♦	Pass
6♥	All Pass		

Bidding a slam missing two aces always makes one look a trifle foolish. Perhaps over Five Diamonds with no other first-round control West should content herself with Five Hearts, but I am not going to apportion blame. It is no surprise that the contract finished one down.

Closed Room

West	North	East	South
Hamdy	C Cambournac	Nabil	G Cambournac
-	-	-	Pass
1♣	2♠	3NT	All Pass

I suspect a bidding panel might not rate too highly the 3NT bid, but who can argue with success. On the lead of a spade North took his ace and switched to a club. Now declarer knocked out the ace of hearts

and had the rest of the tricks and thirteen IMPs for Egypt.

Board 9. Dealer North. E/W Vul.

♠ Q63	♠ N	♠ A7
♥ KJ7	♥ W	♥ 864
♦ K1073	♥ E	♦ 98642
♣ KJ3	♠ S	♣ 976

♠ J95	♠ K10842
♥ A1092	♥ Q53
♦ AQ	♦ j5
♣ 10854	♣ AQ2

Open Room

West	North	East	South
Guerraoui	Hashem	Chamar	Abdelrahman
-	Pass	Pass	1♠
Pass	1NT	Pass	2♣
Pass	4♠	All Pass	

When West elected to lead a trump she solved declarer's problems in the trumps suit and with there being no bad view to take in the diamond suit ten tricks were rapidly stacked in front of declarer.

Closed Room

West	North	East	South
Hamdy	C Cambournac	Nabil	G Cambournac
-	1♦	Pass	1♠
Pass	1NT	Pass	2♣*
Pass	2♠	Pass	4♠
All Pass			
2♣	Checkback		

On a passive lead of a club declarer had to get the trumps right and that was going to be difficult as he would have had to lead them from dummy and then duck a round – certainly counter-intuitive. The result was declarer was one down and 10 IMPs to Egypt.

Egypt won the first session comprehensively 67-20, a healthy but not insurmountable lead.





ABF eyes in all venues

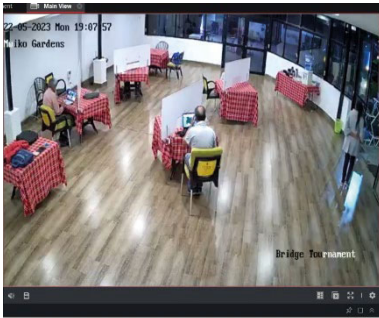

**Kenya venue,
Cam 1**

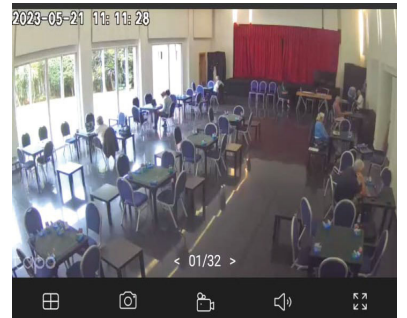

**Morocco venue,
Cam 1**

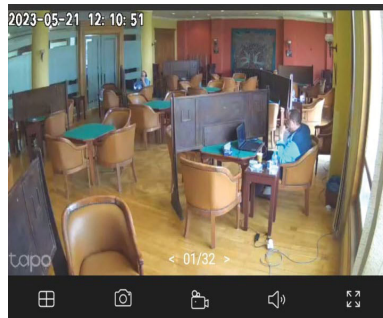

**Egypt venue,
Cam 1**

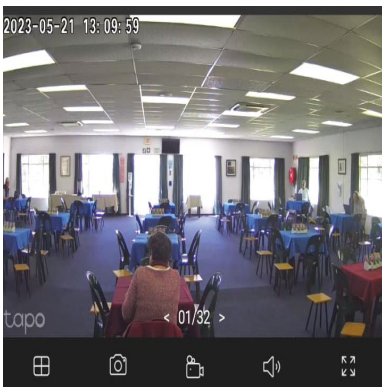

**South Africa-JHB
venue, Cam 1**

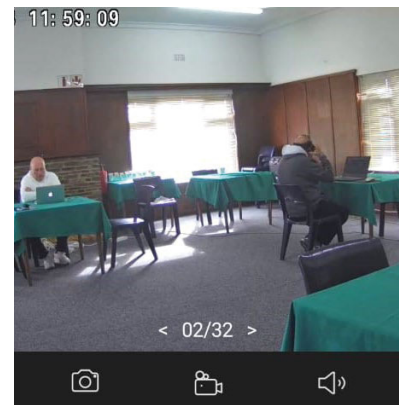

**South Africa-C.T
venue, Cam 1**

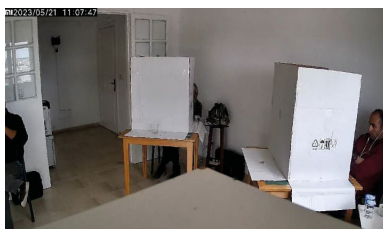

**Tunisia venue,
Cam 1**

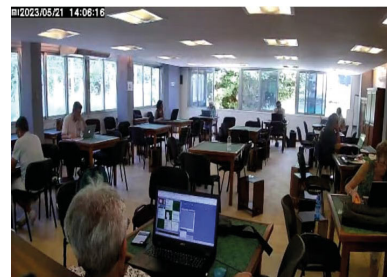

**Reunion venue,
Cam 1**





Senior Championship Day 6 Session 2 Egypt v Reunion

The second session of the Senior Championship final Round Robin had Egypt facing Reunion.

Board 20. Dealer West. All Vul.

♠ 8532	<table border="1"> <tr><td>N</td><td>E</td></tr> <tr><td>W</td><td>S</td></tr> </table>	N	E	W	S	♠ AK9
N		E				
W		S				
♥ 986		♥ A7542				
♦ KJ10	♦ 9					
♣ QJ9	♣ 8654					
	♠ 104					
	♥ 10					
	♦ A86542					
	♣ AK72					

Open Room

West	North	East	South
<i>Simon</i>	<i>Mostafa</i>	<i>Hamel</i>	<i>Zein</i>
Pass	Pass	1♥	2♦
2♥	3NT	All Pass	

East cashed the ace of spades to have a look at dummy and then made the good switch to a club. Declarer won in hand and played ace and another diamond. All West needs to do to ensure the failure of the contract is to lead another club to take out dummy's entry – it is not as though it is difficult to spot, dummy is on view for all to see. All was not lost when he played back a spade for East's king, again all that was needed was a club lead but no the defence refused to take down the contract when East cashed his ace of hearts and now declarer had the rest of the tricks for a remarkable nine tricks

Closed Room

West	North	East	South
<i>Metwally</i>	<i>Vigna</i>	<i>Mokhtar</i>	<i>Lagache</i>
Pass	Pass	1♥	2♦
2♥	2NT	Pass	3♣
Pass	3♦	All Pass	

The par contract and declarer lost the obvious four tricks to make his contract but lost 10 IMPs to Egypt.

Board 21. Dealer North. N/S Vul.

♠ QJ(85)	<table border="1"> <tr><td>N</td><td>E</td></tr> <tr><td>W</td><td>S</td></tr> </table>	N	E	W	S	♠ 3
N		E				
W		S				
♥ 52		♥ AJ76				
♦ A	♦ 10872					
♣ KJ984	♣ A732					
♠ A1042		♠ K76				
♥ 10843		♥ KQ9				
♦ 64		♦ KQJ953				
♣ Q65		♣ 10				

Open Room

West	North	East	South
<i>Simon</i>	<i>Mostafa</i>	<i>Hamel</i>	<i>Zein</i>
–	1♦	Pass	2♦*
Pass	2♠	Pass	3♠
Pass	4♠	All Pass	
2♦	Game forcing		

The diamond lead was won perforce in hand and the jack of spades went round to West's ace. The club switch was ducked to East's ace and the ace of hearts was cashed before continuing diamonds. The king of spades exposed the trump position so declarer was able to draw trumps and claim the remainder to just make his game.

Closed Room

West	North	East	South
<i>Metwally</i>	<i>Vigna</i>	<i>Mokhtar</i>	<i>Lagache</i>
–	1♠	Pass	2♦*
Pass	2♠	Pass	4♣*
Pass	4♠	All Pass	
2♦	Game forcing		
4♣	Splinter		

The same diamond lead, the same play of the ♠Q and the same club play but now East played a second diamond taken in dummy and when declarer decided to play a trump to the queen there was now a trump loser as well as the heart ace and so declarer was done one. 12 IMPs to Egypt.





12th African Bridge Championships



Board 24. Dealer West. None Vul.

♠ K974	<table border="1"> <tr><td>N</td></tr> <tr><td>W E</td></tr> <tr><td>S</td></tr> </table>	N	W E	S	♠ A10853
N					
W E					
S					
♥ K73	♥ Q106				
♦ 82	♦ 106				
♣ K1085		♣ J42			
		♠ 2			
		♥ AJ842			
		♦ AKJ7			
		♣ 763			

Open Room

West	North	East	South
<i>Simon</i>	<i>Mostafa</i>	<i>Hamel</i>	<i>Zein</i>
Pass	Pass	Pass	1♥
Pass	2♦	Pass	3♦
Pass	3NT	All Pass	

The defence started by establishing their spades. Declarer now needed to cash nine tricks before the defence got in and cashed their spade winners. Five diamonds, a heart and a spade plus two clubs with the finesse saw declarer home.

Closed Room

West	North	East	South
<i>Metwally</i>	<i>Vigna</i>	<i>Mokhtar</i>	<i>Lagache</i>
Pass	Pass	Pass	1♥
Pass	2♦	Pass	3♦
Pass	3NT	All Pass	

As per the other table the defence established their spade tricks. Yet another 10 IMPs to Egypt. For reasons I do not understand at trick four declarer played a small heart to the jack which lost to the king and the spades were cashed to take declarer down in a cold contract

Board 30. Dealer East. None Vul.

♠ K5	<table border="1"> <tr><td>N</td></tr> <tr><td>W E</td></tr> <tr><td>S</td></tr> </table>	N	W E	S	♠ AJ7
N					
W E					
S					
♥ 95	♥ 862				
♦ AJ10743	♦ KQ982				
♣ AK2		♣ 76			
♠ 8643		♠ Q1092			
♥ Aj107		♥ KQ43			
♦ —		♦ 65			
♣ 98543		♣ QJ10			

Open Room

West	North	East	South
<i>Simon</i>	<i>Mostafa</i>	<i>Hamel</i>	<i>Zein</i>
—	—	Pass	Pass
Pass	1♦	Pass	1♥
Pass	3♦	Pass	3NT

All Pass

West led a club, won in hand and led a diamond – getting the bad news – letting it run to East who switched to a heart and West allowed declarer to hold the trick. A spade to the king and ace and another heart won by West who exited with a spade but no matter what declarer did he only had eight tricks.

Closed Room

West	North	East	South
<i>Metwally</i>	<i>Vigna</i>	<i>Mokhtar</i>	<i>Lagache</i>
—	—	Pass	Pass
Pass	1NT	Pass	2♣
Pass	2♦	Pass	3NT

All Pass

East was probably surprised after her fourth best ♦8 saw her partner discard, winning with the ♦10 declarer led a heart to the king which was allowed to hold. Now a spade to the king was captured by East's ace and another heart ducked in dummy but West was forced to win and exited with a club taken in hand and a spade to the ♠9 held. Declarer read the cards well and cashed her top tricks before exiting with a heart to West, who could cash another but was forced to lead a spade. This way declarer made the contract whoever was the guardian of the jack of spades. 10 IMPs to Reunion.

At the end of the match Egypt had a comfortable win 16.26-3.74 VPs.





Your Chief Tournament Director Waleed El Menyawi explains the important procedures to be observed during the Championships:

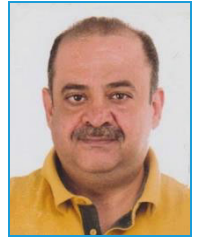

Play Links

Each category will have its own playing link (Open teams link – Women teams link .. etc. Play links will be posted to the captains' WhatsApp group and will be also posted to the ABF website at the following link

https://www.bridgewebs.com/cgi-bin/bwop/bw.cgi?club=abf&pid=display_page24

Click the Match number, official start time or Session open time of your category to join the game. The game will be open to players 30 min before the official start time.

1. Open, Women & Mixed Categories.

For the Semi-final, Final and play-off sessions, It has been decided that:

- The team ranked higher after the RR stage will be the Home team in sessions 2 and 4 in the Semi-final match.
- The team ranked lower after the RR stage will be the Home team in sessions 1 and 3 in the Semi-Final match.
- The team ranked higher after the RR stage will be the Home team in session 2 in the Final or Play-off match.
- If Morocco team qualify to the final match in any category, there will be a 4 Segments play-off match between the semi-final losers to determine the team to qualify to Marrakesh.

2. All Africa Pairs tie-break procedure

If two pairs or more have the same cumulative score after the end of the 2nd session or 4th Session, the tie shall be broken as follows:

- A. The pair with the higher score in the 2nd / 4th session shall determine the final ranking.
- B. Mutual boards between the tied pairs - if applicable -

3. Teams Events ... Last RR

The last Round Robin for all categories shall be done according to the final ranking of the teams in the previous played rounds.

4. Click the link below for instructions

[Alert Procedures - Undo Procedures - General Instructions](#)

5. Play instructions and Schedule of play ...

- A. When you log on to the RealBridge game (using the game link), you will find your team name written in one of the Tables.
- B. All team members are required **to sit at their table (all together)** in Pairs NS and EW, later on, when we start the session, the software will automatically move the EW pairs between the tables according to the schedule of play.





that the process had not been followed properly in some material way, the Reviewer will ask the Head TD to correct the failings and issue a new ruling.

8. Time delay and hesitation

- It is very important to know that the TDs have the tools to produce a board report which includes the time for each bid / play by each player, so please be bare that in mind when calling the TD for a possible hesitation or before denying it.

- It is also very important to know that the TDs also have the tools to produce a session time report which includes the exact time taken by each player in a session, in case of time delay, the penalty will be given according to this report.

9. Home & Visiting teams

- When you log in to the RealBridge game (using the game link), you will find your team name written on one of the Tables.
- All team members are required to sit at their table (all together) in Pairs NS and EW, later on, when we start the session, the software will automatically move the EW pairs between the tables according to the schedule of play.
- In the schedule of play you will find Home team (the team mentioned first) and Visiting team (the team mentioned second)
- NO LINE-UP will be needed from the teams, the visiting team has to sit first at their table (in Pairs NS and EW), minimum 10 min before the official start time, and the Home team has the right to have a look at the visiting team and sit its pairs accordingly.

10. Headphones / Earphones

In order to minimize the noise in the venue as much as possible...

- It is mandatory for each player to have his own headphone / earphone which is connected to his device during play
- Use the table chat / private chat as much as possible and don't use vocal chat.
- Any vocal explanation will not be taken into the TD consideration in any case.
- You need to be very careful when using the table chat as you might give an unauthorized information to your partner which could results in adjusted score by the TD.

11. Kibitzers

- Kibitzers are not allowed by any means at 1) the playing venue, 2) RealBridge online playing room.
- All players are required to immediately leave the playing area when they finish their session, players are also kindly asked to keep their seats and not roam around the playing area.
- All the matches will be broadcasted via RealBridge kibitzer website...

<https://kibitz.realbridge.online/>





determined a slightly different ruling would not be good reason for the ruling to be varied. In the event that the process had not been followed properly in some material way, the Reviewer will ask the Head TD to correct the failings and issue a new ruling.

8. Time delay and hesitation

- It is very important to know that the TDs have the tools to produce a board report which includes the time for each bid / play by each player, so please be bare that in mind when calling the TD for a possible hesitation or before denying it.
- It is also very important to know that the TDs also have the tools to produce a session time report which includes the exact time taken by each player in a session, in case of time delay, the penalty will be given according to this report.

9. Home & Visiting teams

- When you log in to the RealBridge game (using the game link), you will find your team name written on one of the Tables.
- All team members are required to sit at their table (all together) in Pairs NS and EW, later on, when we start the session, the software will automatically move the EW pairs between the tables according to the schedule of play.
- In the schedule of play you will find Home team (the team mentioned first) and Visiting team (the team mentioned second)
- NO LINE-UP will be needed from the teams, the visiting team has to sit first at their table (in Pairs NS and EW), minimum 10 min before the official start time, and the Home team has the right to have a look at the visiting team and sit its pairs accordingly.

10. Headphones / Earphones

In order to minimize the noise in the venue as much as possible...

- It is mandatory for each player to have his own headphone / earphone which is connected to his device during play
- Use the table chat / private chat as much as possible and don't use vocal chat.
- Any vocal explanation will not be taken into the TD consideration in any case.
- You need to be very careful when using the table chat as you might give an unauthorized information to your partner which could results in adjusted score by the TD.

11. Kibitzers

- Kibitzers are not allowed by any means at 1) the playing venue, 2) RealBridge online playing room.
- All players are required to immediately leave the playing area when they finish their session, players are also kindly asked to keep their seats and not roam around the playing area.
- All the matches will be broadcasted via RealBridge kibitzer website...

<https://kibitz.realbridge.online/>





- At the RealBridge kibitzer website, you can find the live broadcasted matches and also all the other matches scheduled for broadcast.
- For security reasons, all broadcasted matches will be delayed by 30-45 min.

12. Smoking, Eating and Alcohol, Mobile and electronic devices

We must act as if we were playing these championships "live", therefore, the following is strictly forbidden during play:

- Mobile phones and any other electronic devices, Mobile phones will be collected and there will be a regular check each session by the monitor.
- Eating (even if only biscuits)
- Drinking Alcohol
- Smoking
- Going to the WC without permission
- Talking loudly during or at the end of any board if the player is unhappy about his/her partner's bid, hand play or defense.

46th WORLD BRIDGE TEAMS CHAMPIONSHIPS 13th WORLD TRANSNATIONAL OPEN TEAMS Marrakech, Morocco • 20 August - 2 September 2023* **Registration and Opening Ceremony on 19 August*





RealBridge Playing Instructions

First : Log in , Lobby, at the table and Settings

1. To join any RealBridge game you will need a **LINK**

2. All the play links will be available on ABF website

https://www.bridgewebs.com/cgi-bin/bwop/bw.cgi?club=abf&pid=display_page24

AND you might also receive it by mail.

3. Click the link and you will be redirected to the log on page of our game which looks like the next figure ...

Notice that your video should appear in the right bottom corner of the page and mic volume showing that it works.

4. If you can't see your video then you need to allow your browser to use your cam and mic, do as follows to allow it

5. From Goggle Chrome and just before the address bar, press the lock icon

6. Allow cam and allow mic.

7. Write your name in the required field and press login – nothing else is to be done- **NO ID number will be used, (leave it blank)**

8. When you logged in you will see the lobby which almost looks like the following figure (**but this figure includes extra buttons for TDs**)

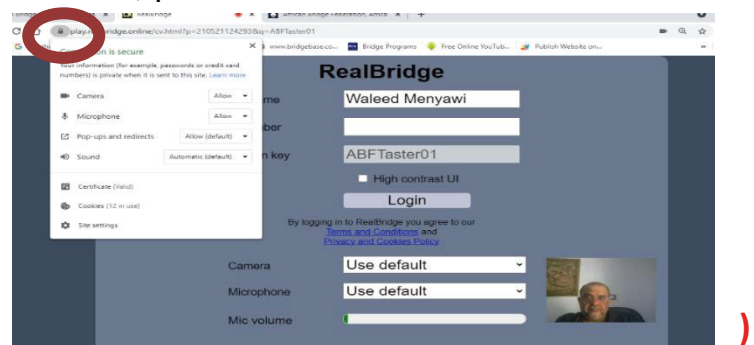
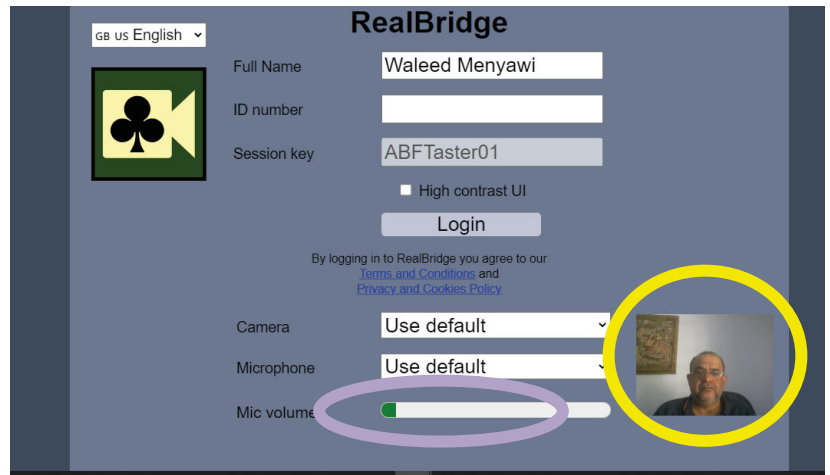

Notice the lobby chat window to the right.

**Keep an eye to the Lobby chat
- For important announcements**





12th African Bridge Championships



9. Each table labeled with a team name, find your table and chose where to sit (Sit N, Sit S, Sit E or Sit W)

10. Get familiar with the buttons at your table and call the TD using the button for help.

Volume control for your partner.

Volume control for left-hand opponent. You have a separate volume control for each player. This only affects what you hear.

Private chat with left-hand opponent. You can chat privately only with the opponents, not partner

Volume control for right-hand opponent.

Private chat with right-hand opponent.

Disable/enable your video.

Disable / enable your microphone. Use this when you're on the phone!

Hide / unhide the other players' videos. Use this if you have a poor connection.

Redial. Restarts audio and video connections. Use it if the connection fails, or if your video or audio gets out of sync.

Settings

Display style

- Detailed cards
- Simplified cards

Deal animation

Slide

Animation duration

[Slider]

As defender, see dummy

- Facing declarer
- Facing me

As declarer, see dummy as

- Vertical suits (facing declarer)
- Horizontal hand

Input style

- One click or tap
- Two taps (tablet)
- Double click (mouse)

OK Cancel

"Detailed cards" shows pictures of cards; "Simplified cards" are schematic and have larger symbols

The orientation of dummy's cards when you are defending.

The orientation of dummy's cards when you are declaring.

Choose the way you make bids and plays. With "Two taps", the first tap selects the card, then the second tap confirms. "Double click" means that you make two fast clicks.

This controls how a new hand arrives at the beginning of each deal. Choose an effect, or set to "None" to have the hand simply appear.

If you have an animation enabled, use the slider to control how long the animation lasts.





11. After we play all boards

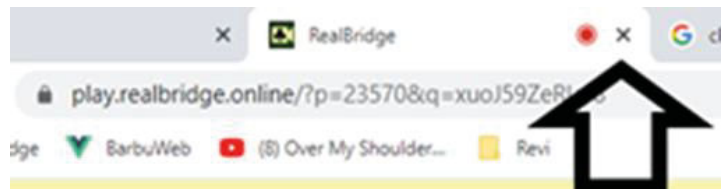

Leave RealBridge, close the tab. See the small X? just click it.



12. Can Use and Can't use

Can Use	Can't use
<ul style="list-style-type: none"> • Windows laptop • Windows desktop • MacBook or another Apple laptop • iMac or another Apple desktop • Chromebook 	<ul style="list-style-type: none"> • Smartphone • Old iPads, older than 2018.

You must use one of these web browsers (you probably are using one of them!):

Can Use ü	Can't use û
<p>Edge, Chrome, Firefox, Safari. The logo must look like one of these – exactly as below. If it looks different, you are using an out-of-date version. <i><u>If you are choosing amongst your browsers, we advise that you chose something other than Firefox.</u></i></p>	<p>Internet Explorer (notice the gold band) The old EDGE (see shape of the e)</p>
	

Second : Bidding, Play, Alert and System

13. **At the start** of any session, All the team members are required to be seated at the same table (Table with the **team name label**), the system will automatically move the EW pairs to the opponents table when we start the session **and will send them back to their home table when both tables finish playing the boards.**

14. **Private chat and Table chat**

- It is strongly recommended to use the chat rather than the vocal chat; the TDs will not take into consideration any vocal explanation if you have any case.
- I will show you now, 2 figures and will appoint to you where to find the table chat (where the 4 players can see your chat) and where to find the private chat where you can chat privately with one of your opponents (not your partner of-course 😊).



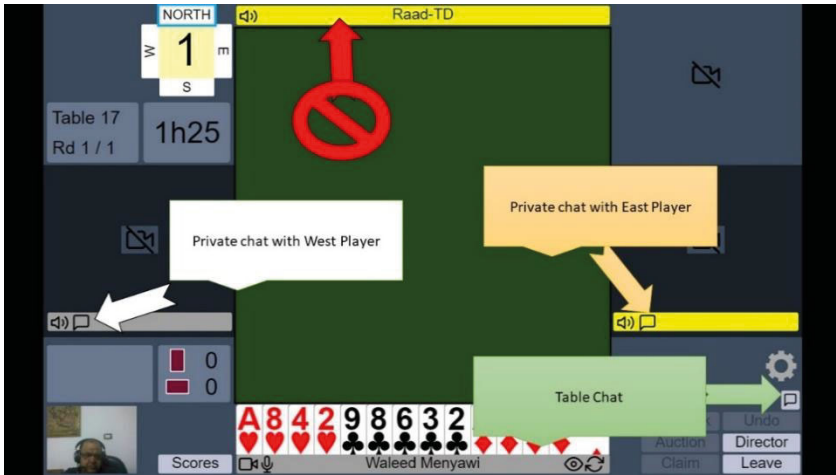

When you are at Full Screen mode

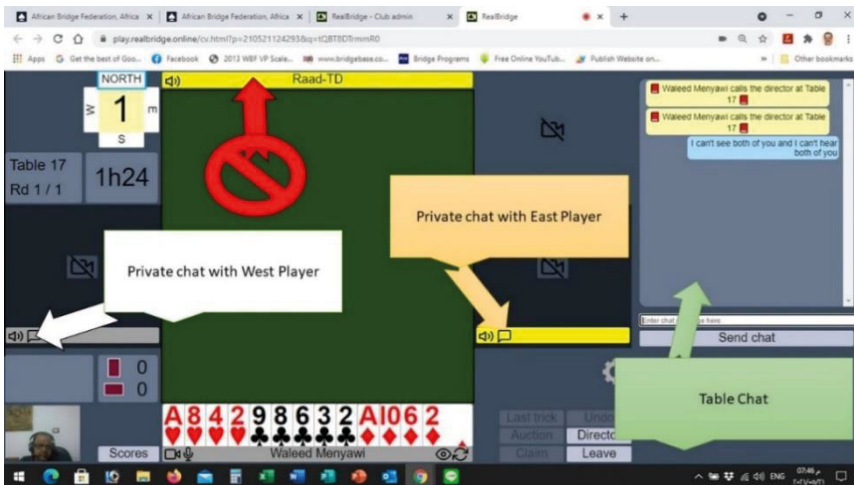

When you are at normal view (NOT Full Screen mode

15. Self-alert and self-explanation proper procedure:

1. Click alert (if required)
2. Write / Put in explanation
3. Make bid

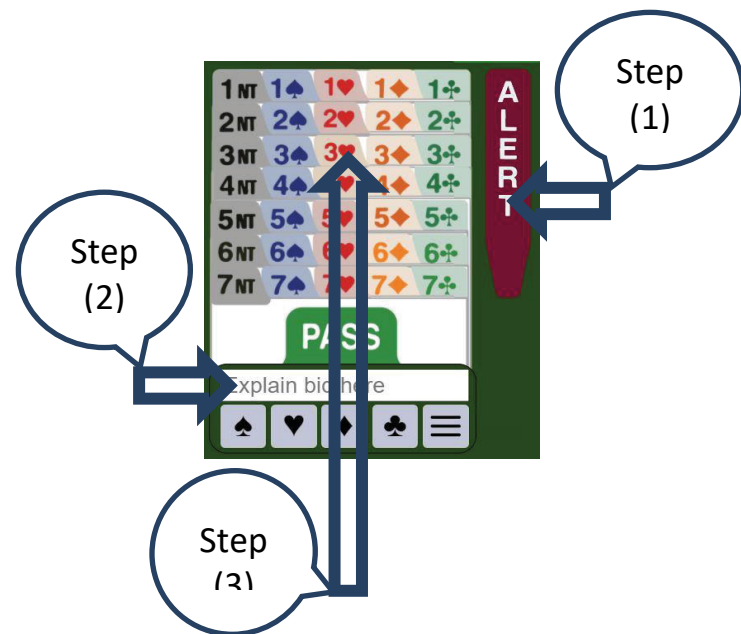



If you make a **mistake** or need to **explain your bid further** after you have bid, you can click on the bid and add more text.

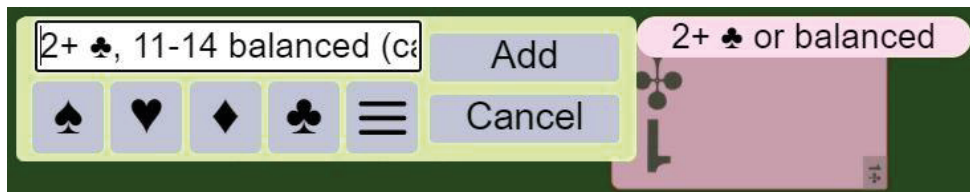

The added text will appear after an asterisk *. The time in seconds between when the bid was **made** and the added explanation was **submitted** is presented after the added text in the square brackets, for this example, 26 seconds. The character limit on explanations is 200 characters.

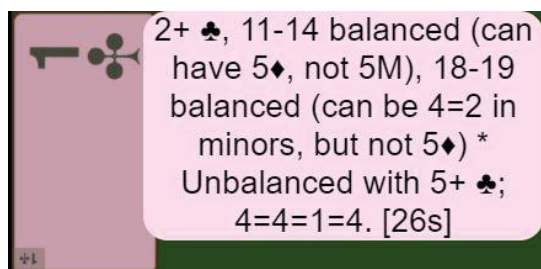

16. System

All teams are required to write a brief about their system at the table chat box before the start of first board in each match.

