



Welcome To The Twelfth African Bridge Championships

Dear Competitors, Dear Officials, Dear Friends,

A very warm welcome to you to the 12th Zonal Championship held on “RealBridge” Platform.

On behalf of our ABF Management Team (Chafika Taktak, Helen Kruger, Samina Esmail and Jean-Claude Cador), I am grateful to you (Players and NBOs) for having supported us in organizing this Continental Event, for the second time, on-line.

For all of us, in Zone 8, 2023 will be remembered as a very special Year. For the first time since the creation of our Zone, we are holding a World Championship on our dear Continent, in the beautiful Marrakech, Morocco. And it is the “crème de la crème” of all World competitions: the World Teams Championships in the four categories. But to be fair, this is the second time our continent hosts a World-wide Bridge event; Hammamet, Tunisia, hosted the same competition some 26 years ago, in 1997 and it was a great success.

On behalf of our Zone 8, I would like to express our gratitude to the WBF Executive Committee and our Past President, **Gianarrigo Rona**, as well as to our new President, **Jan Kamras**, for having trusted Morocco in hosting this Worldwide event.

As a consequence of the above, Zone 8 will have three teams, in each category, competing in Marrakech: Morocco, the host, and two other Teams – a real huge opportunity for us and for the first time.

And here, I would like to mention our Moroccan NBO President **Abdellatif Belkouch** and his team, for having accepted to participate, with four Teams, in our Zonal trials even though they are naturally qualified for Marrakech. I sincerely hope it will also be a great opportunity for their four teams to get a strong preparation for the World competition.



continued on next page

This message from Bernard Pascal is repeated in French on the back page.

All information can be found on the website:

www.bridgewebs.com/abf/





The Open Teams defending their success in 2021



The winning Egypt Open Team (from left to right) Walid El Ahmady, Tarek Sadek, Reda Amiry, Ahmed Samir, Baher Ahmed and Hussein Sherif

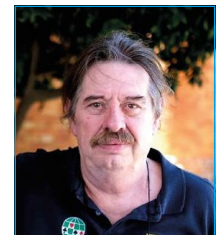
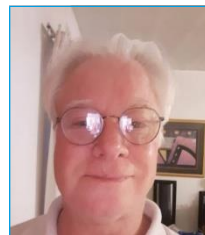
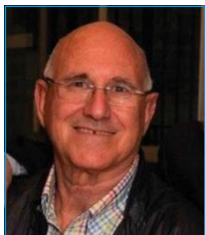

The South Africa Team, also going to the Bermuda Bowl (from left to right) Neville Eber, Hennie Fick, Craig Gower, Alon Apteker, Andrew Cruise and Tim Cope

Presidential Welcome - continued from Front Page

Since we are talking about Marrakech, we also owe our full gratitude to **Mrs Chafika Taktak**, the President of the local organizing committee of the World championships, who has been working, together with her team, tirelessly, and continue to, in order to make it a big success. “Thank you” Chafika and “thank you” to her Team.

Our CTD and Director of Operations, “Jack of all trades”, **Waleed El Menyawi**, brings us the comfort of orchestrating, once more, 2023 Zonal trials. Thank you for your continuous dedication to Zone 8 dear Waleed.

Effective now, through this first bulletin, and through the following ones, you will be able to read, every day, all the updates, news, results and many other subjects **Ron Tacchi** is concocting for you, and we thank him for it.

Tomorrow, we start with our traditional “ALL AFRICA” Open Pairs and we had to modify the format due to the unfortunate low number of entries. Therefore, we will be playing three sessions (one on Friday at 11am GMT and two on Saturday at 10am and 2:45pm GMT) and, since I will participate, I will enjoy meeting all competitors and greet them personally. Make sure you are one of the six best pairs in order to receive ABF monetary rewards.

Now, and to all participating Teams, you are about to confront with our best continental players so be ready to enjoy, fight and win. I look forward to congratulating the Teams who will qualify for Marrakech at the end of week one, for the Seniors and Mixed, and, by end of week two, for Ladies and Open.

Good luck to all and thank you for making this event a friendly and competitive one.

Bernard Pascal





The Women Teams defending their success in 2021



The winning Egyptian Women Team (from left to right) Nadia Taymour, Nessrine Hamdy, Hoda Soliman, Dina El Awady, Margeurite Homsy and Nada Wattar

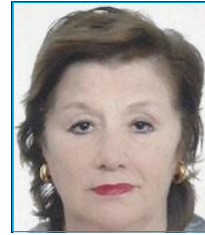
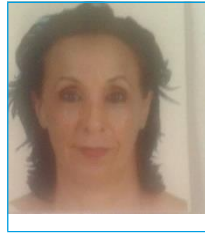

The second team qualifying for the Venice Cup (from left to right) Fatim Lahlou, Hayat Hachimi, Farida Guerraoui, Catherine t'Kint, Marie Claire Ohana and Khadija Marrakchi

The Mixed Teams defending their success in 2021



The winning Egyptian Mixed Team (from left to right) Somaya Wahdan, Manal Sallam, Maud Khouri, Ahmed Harb, Moaz Hammam and Mohamed Heshmat

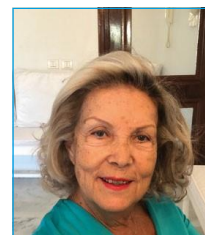

The second team qualifying for the Wuhan Cup, Tunisia (from left to right) Abdeljelil Trabelsi, Ferdaous Trabelsi, Meriem Dorai, Hassouna Abdelmalek, Hedia Baccar and Moncef Daghmouri





All-Africa Pairs, 19 & 20 May, 2023

The All-Africa Pairs will commence at 11H00 AM GMT Friday 19 May and will be played over 3 cumulative sessions. The full schedule is shown below.

Friday 19 May: First Session at 11H00 GMT:

Saturday 20 May: Second Session at 10H00 GMT & Third Session at 2H30 GMT.

Full information can be read at

https://www.bridgewebs.com/cgi-bin/bwop/bw.cgi?club=abf&pid=display_page21.

The competition will run on RealBridge and thus special Online Procedures will apply - these are summarised elsewhere within this document but a full version is available at ABF website, further set of procedures, also summarised elsewhere (The Head Tournament Director's Announcements and Instructions) can be found online at

https://www.bridgewebs.com/cgi-bin/bwop/bw.cgi?club=abf&pid=display_page19.

The format will be three cumulative sessions, complete Howell movement.

The Systems and Alerting Policies are detailed within this Bulletin and it is strongly advised that each competitor make themselves aware of all of them.

Local Time

All times quoted within the Bulletins are GMT:

Morocco and Tunisia are one hour ahead, +1

South Africa is two hours ahead, +2

Egypt and Kenya are three hours ahead. +3

Reunion is four hours ahead, +4

So at 2.00 p.m. it is 3.00 p.m. in Morocco and Tunisia, 4.00 p.m. in South Africa, 5.00 p.m. in Kenya and Egypt and 6.00 p.m. in Reunion.

All-Africa Pairs Schedule

Day	Date	Session	From (GMT)	To (GMT)	# Boards
Friday	19.05.2023	First	11H00 AM	02H30 PM	27 Boards
Saturday	20.05.2023	Second	10H00 AM	01H30 PM	27 Boards
Saturday	20.05.2023	Third	02H45 PM	06H15 PM	27 Boards





Rosters for All-Africa Pairs

Egypt	
Mahmoud Zaitoun	Karim Azmy
Hany Dagher	Bernard Pascal
Kenya	
Bijal Shah	Sejal Shah
Samina Esmail	Sumi shah
Bhanumati Shah	Ramula Kumar Shah
Morocco	
Fatim Lahlou	Stephane Dahan
Ismail Chamar	Ahmed Moulay Kacimi
Reunion	
Jean-Luc Neulat	Gabriel Melin
Christian Giraud	Narguis Huseinali
Patrick Hamel	Philippe Lagache
Régine Wan Hoi	Michel Lemarinel
TUN-EGY	
Emna Chelbi	Mohamed Thabet

South Africa	
Glen Holman	Erica Zimet
Brian Pincus	Dinner Minwalla
Roz Bernstein	Sharon Lang
Craig Gower	Diana Rosslee
Diana Balkin	Sharon Izerel
Peta Balderson	Jennifer Gautschi
Moshe Fayman	Maria Fayman
Zela Stern	Carol Stanton
Andre van Niekerk	Rose Duff
Imtiaz Kaprey	Duncan Keet
Hennie Fick	Neville Eber
Lotte Sorensen	Jude Apteker
Helen Kruger	Joel Harris
Aras Apteker	Chris Bosenberg
Nicola Bateman	Rob Stephens

The Senior Teams defending their success in 2021



The winning Moroccan Senior Team (from left to right) Said Berrada, Abelkamel Rerhaye, Abdellah El Ghrari, Jean Hayet, Guy Cambournac and Khalil Bensouda



The second team qualifying for the d'Orsi Cup, Egypt (from left to right) Mohamed Tanbouli, Ashraf Wahdan, Adel El Kordy, Amr Farrag, Mohamed El Baz and Ayman Azzam





Your Chief Tournament Director Waleed El Menyawi explains the important procedures to be observed during the Championships:

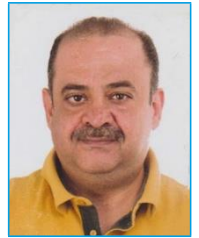

Play Links

Each category will have its own playing link (Open teams link – Women teams link .. etc. Play links will be posted to the captains' WhatsApp group and will be also posted to the ABF website at the following link

https://www.bridgewebs.com/cgi-bin/bwop/bw.cgi?club=abf&pid=display_page24

Click the Match number, official start time or Session open time of your category to join the game. The game will be open to players 30 min before the official start time.

1. Open, Women & Mixed Categories.

For the Semi-final, Final and play-off sessions, It has been decided that:

- The team ranked higher after the RR stage will be the Home team in sessions 2 and 4 in the Semi-final match.
- The team ranked lower after the RR stage will be the Home team in sessions 1 and 3 in the Semi-Final match.
- The team ranked higher after the RR stage will be the Home team in session 2 in the Final or Play-off match.
- If Morocco team qualify to the final match in any category, there will be a 4 Segments play-off match between the semi-final losers to determine the team to qualify to Marrakesh.

2. All Africa Pairs tie-break procedure

If two pairs or more have the same cumulative score after the end of the 2nd session or 4th Session, the tie shall be broken as follows:

- A. The pair with the higher score in the 2nd / 4th session shall determine the final ranking.
- B. Mutual boards between the tied pairs - if applicable -

3. Teams Events ... Last RR

The last Round Robin for all categories shall be done according to the final ranking of the teams in the previous played rounds.

4. Click the link below for instructions

[Alert Procedures - Undo Procedures - General Instructions](#)

5. Play instructions and Schedule of play ...

- A. When you log on to the RealBridge game (using the game link), you will find your team name written in one of the Tables.
- B. All team members are required **to sit at their table (all together)** in Pairs NS and EW, later on, when we start the session, the software will automatically move the EW pairs between the tables according to the schedule of play.





C. In the schedule of play you will find Home team (the team mentioned first) and Visiting team (the team mentioned second)

D. The visiting team has to sit first at their table (Pairs NS and EW) and the Home team has the right to have a look at the visiting team and sit its pairs accordingly.

6. Open, Women & Mixed Categories.

- Teams from all categories, the top four teams will qualify to the semi-final stage after playing 3 complete RR according to the published schedule.
- The top ranked team after the 3 complete RR stage will choose their opponent in the semi-final and the remaining 2 teams will play against each other's.
- The semi-final match will be played in 4 Sessions, 16 boards each in IMPs.
- The final match between the semi-final winners will be played in 2 Sessions, 16 Boards each.
- Play-off between the semi-final losers will be played in 2 Sessions, 16 Boards each to determine the 3rd placed team.
- In all the knock out stages, there shall be a carry-over = 0.5 IMP to the team who scored more VPs in the RR stage.

Seniors Category.

- 6 Complete RR over 6 days to determine the qualified two teams, followed by 2 segments final between the top 2 teams to determine the title winner.
- The team achieved the 3rd place after the 6 RR will qualify to the World Bridge championships in case that Morocco Senior teams qualify for the final match.

7. Request a review

1. First step is to review the TD ruling with the Head TD
2. Second step is to apply for an official review by submitting a review form through the TD in charge of your case.
3. A request for a review of a Tournament Director's ruling must be lodged within 30 minutes of the first posting of the official score for the Session in which the board was played that is the subject of the ruling. All such requests must be lodged by the team's Captain or his designee, or by one member of the pair in the Pairs events.
4. When lodging a Request for Review the appellant must make a monetary deposit with the ABF monitor. The amount of deposit required will be US \$ 100 (or the equivalent in Euro)
5. The case will be reviewed by a person who was not involved in the original decision. The Reviewer will check that the TD has gathered the necessary evidence of what occurred when the infraction arose. The Reviewer will then need to be satisfied that the correct law was applied and that other TDs were consulted where appropriate. In matters involving the judgement that was exercised by a player following unauthorized information, incorrect explanation or failure to alert, the Reviewer will clarify that suitable players have been asked appropriate questions to enable a judgmental view to be obtained. Finally, the Reviewer will check that the ruling that was issued based upon all the information available to the TDs was within the bounds of reasonableness. The fact that the Reviewer might have





determined a slightly different ruling would not be good reason for the ruling to be varied. In the event that the process had not been followed properly in some material way, the Reviewer will ask the Head TD to correct the failings and issue a new ruling.

8. Time delay and hesitation

- It is very important to know that the TDs have the tools to produce a board report which includes the time for each bid / play by each player, so please be bare that in mind when calling the TD for a possible hesitation or before denying it.
- It is also very important to know that the TDs also have the tools to produce a session time report which includes the exact time taken by each player in a session, in case of time delay, the penalty will be given according to this report.

9. Home & Visiting teams

- When you log in to the RealBridge game (using the game link), you will find your team name written on one of the Tables.
- All team members are required to sit at their table (all together) in Pairs NS and EW, later on, when we start the session, the software will automatically move the EW pairs between the tables according to the schedule of play.
- In the schedule of play you will find Home team (the team mentioned first) and Visiting team (the team mentioned second)
- NO LINE-UP will be needed from the teams, the visiting team has to sit first at their table (in Pairs NS and EW), minimum 10 min before the official start time, and the Home team has the right to have a look at the visiting team and sit its pairs accordingly.

10. Headphones / Earphones

In order to minimize the noise in the venue as much as possible...

- It is mandatory for each player to have his own headphone / earphone which is connected to his device during play
- Use the table chat / private chat as much as possible and don't use vocal chat.
- Any vocal explanation will not be taken into the TD consideration in any case.
- You need to be very careful when using the table chat as you might give an unauthorized information to your partner which could results in adjusted score by the TD.

11. Kibitzers

- Kibitzers are not allowed by any means at 1) the playing venue, 2) RealBridge online playing room.
- All players are required to immediately leave the playing area when they finish their session, players are also kindly asked to keep their seats and not roam around the playing area.
- All the matches will be broadcasted via RealBridge kibitzer website...

<https://kibitz.realbridge.online/>





- At the RealBridge kibitzer website, you can find the live broadcasted matches and also all the other matches scheduled for broadcast.
- For security reasons, all broadcasted matches will be delayed by 30-45 min.

12. Smoking, Eating and Alcohol, Mobile and electronic devices

We must act as if we were playing these championships "live", therefore, the following is strictly forbidden during play:

- Mobile phones and any other electronic devices, Mobile phones will be collected and there will be a regular check each session by the monitor.
- Eating (even if only biscuits)
- Drinking Alcohol
- Smoking
- Going to the WC without permission
- Talking loudly during or at the end of any board if the player is unhappy about his/her partner's bid, hand play or defense.

46th WORLD BRIDGE TEAMS CHAMPIONSHIPS 13th WORLD TRANSNATIONAL OPEN TEAMS

Marrakech, Morocco • 20 August - 2 September 2023*

**Registration and Opening Ceremony on 19 August*

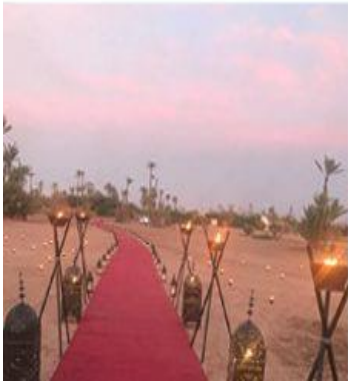



Roster - Senior Teams

Egypt

Captain Amr Farrag
Adel El Kourdy
Ayman Azzam
Mokhtar Bassyouni
Tarek Metwali
Ahmed Zein
Ismail Moustafa

Morocco

Captain Abdelkamel Rerhaye
Abdellatif Belkouch
Mohamed Dinia
Mohamed Said Berrada
Khalil Bensouda
Abdellah Elghrari
Abdelkamel Rerhaye

Reunion

Captain Patrice Dordhain
Patrice Dordhain
Jean-Marc Breslaw
Patrick Hamel
Philippe Simon
Geneviève Vigna
Philippe Lagache

South Africa

Captain James Grant
James Grant
Larry Chemaly
Michael Alexander
Maureen Narunsky
Brian Pincus
Diniar Minwalla





12th African Bridge Championships



GMT TIME

Senior Teams Schedule of play

Each Match = 16 Boards in 2H 15min

R.R (01)		Match (01), 09H00			Match (02), 12H30			Match (03), 15H15		
Date	Table No.	Home Team	X	Visiting Team	Home Team	X	Visiting Team	Home Team	X	Visiting Team
SUN 21	1	1 MOR	x	4 REU	3 RSA	x	1 MOR	1 MOR	x	2 EGY
	2	2 EGY	x	3 RSA	4 REU	x	2 EGY	3 RSA	x	4 REU
R.R (02)		Match (01), 09H00			Match (02), 12H30			Match (03), 15H15		
Date	Table No.	Home Team	X	Visiting Team	Home Team	X	Visiting Team	Home Team	X	Visiting Team
MON 22	1	4 REU	x	1 MOR	1 MOR	x	3 RSA	2 EGY	x	1 MOR
	2	3 RSA	x	2 EGY	2 EGY	x	4 REU	4 REU	x	3 RSA
R.R (03)		Match (01), 09H00			Match (02), 12H30			Match (03), 15H15		
Date	Table No.	Home Team	X	Visiting Team	Home Team	X	Visiting Team	Home Team	X	Visiting Team
TUE 23	1	1 MOR	x	4 REU	3 RSA	x	1 MOR	1 MOR	x	2 EGY
	2	2 EGY	x	3 RSA	4 REU	x	2 EGY	3 RSA	x	4 REU
RR (04)		Match (01), 09H00			Match (02), 12H30			Match (03), 15H15		
Date	Table No.	Home Team	X	Visiting Team	Home Team	X	Visiting Team	Home Team	X	Visiting Team
WED 24	1	4 REU	x	1 MOR	1 MOR	x	3 RSA	2 EGY	x	1 MOR
	2	3 RSA	x	2 EGY	2 EGY	x	4 REU	4 REU	x	3 RSA
R.R (05)		Match (01), 09H00			Match (02), 12H30			Match (03), 15H15		
Date	Table No.	Home Team	X	Visiting Team	Home Team	X	Visiting Team	Home Team	X	Visiting Team
THU 25	1	1 MOR	x	4 REU	3 RSA	x	1 MOR	1 MOR	x	2 EGY
	2	2 EGY	x	3 RSA	4 REU	x	2 EGY	3 RSA	x	4 REU
R.R (06)		Match (01), 09H00			Match (02), 12H30			Match (03), 15H15		
Date	Table No.	Home Team	X	Visiting Team	Home Team	X	Visiting Team	Home Team	X	Visiting Team
FRI 26	1	4 REU	x	1 MOR	1 MOR	x	3 RSA	2 EGY	x	1 MOR
	2	3 RSA	x	2 EGY	2 EGY	x	4 REU	4 REU	x	3 RSA

SAT, 27

FINAL

	EGY +3	KEN +3	MOR +1	REU +4	RSA +2	TUN +1
09H00 GMT =	12H00 PM	12H00 PM	10H00 AM	01H00 PM	11H00 AM	10H00 AM
12H30 GMT =	03H30 PM	03H30 PM	01H30 PM	04H30 PM	02H30 PM	01H30 PM
15H15 GMT =	06H15 PM	06H15 PM	04H15 PM	07H15 PM	05H15 PM	04H15 PM





Roster - Mixed Teams

Egypt

Captain

Ahmed Zayed

Mohamed Heshmat

Fatima Mandilly

Dalia Hashem

Abdelrahman Khedr

Nessrine Hamdy

Karim Nabil

Kenya

Captain

Samina Ismail

Samina Ismail

Saleem UD Deen

Bhanumati Shah

Jayantilal Kharia

Aruna Shah

Chandrakant Shah

Morocco

Captain

Farida Guerraoui

Farida Guerraoui

Ismail Chamar

Guy Cambournac

Chantal Cambournac

Abderrahim Tazi

Noufissa Sebti

Reunion

Captain

Christian Giraud

Christian Giraud

Narguis Huseinali

Régine Wan Hoi

Michel Lemarinel

Denise Bauquier

Jean-Luc Neulat

South Africa

Captain

Lex van Vught

Lex van Vught

Joy Rothenberg

Craig Gower

Rita Gawron

Tim Cope

Janine Masojada

Tunisia

Captain

Hassouna Ben Abdelmalek

Monia Klibi

Wissem Bellazreg

Anas Mestiri

Maissa Farhani

Hedia Sellami

Mohamed Ali Lakhdhar





12th African Bridge Championships



GMT TIME

Mixed Teams Schedule of play

Each Match = 16 Boards in 2H 15min

R.R (01)		Match (01), 09H00				Match (02), 12H30				Match (03), 15H15			
Date	Table No.	Home Team	X	Visiting Team	Home Team	X	Visiting Team	Home Team	X	Visiting Team	Home Team	X	Visiting Team
SUN 21	1	1 EGY	x	6 KEN	5 RSA	x	1 EGY	1 EGY	x	4 REU	1 EGY	x	4 REU
	2	2 TUN	x	5 RSA	6 KEN	x	4 REU	5 RSA	x	3 MOR	5 RSA	x	3 MOR
	3	3 MOR	x	4 REU	2 TUN	x	3 MOR	6 KEN	x	2 TUN	6 KEN	x	2 TUN
R.R (01)		Match (04), 09H00				Match (05), 12H30				RR(02) Match (01), 15H15			
Date	Table No.	Home Team	X	Visiting Team	Home Team	X	Visiting Team	Home Team	X	Visiting Team	Home Team	X	Visiting Team
MON 22	1	3 MOR	x	1 EGY	1 EGY	x	2 TUN	6 KEN	x	1 EGY	6 KEN	x	1 EGY
	2	4 REU	x	2 TUN	3 MOR	x	6 KEN	5 RSA	x	2 TUN	5 RSA	x	2 TUN
	3	5 RSA	x	6 KEN	4 REU	x	5 RSA	4 REU	x	3 MOR	4 REU	x	3 MOR
R.R (02)		Match (02), 09H00				Match (03), 12H30				Match (04), 15H15			
Date	Table No.	Home Team	X	Visiting Team	Home Team	X	Visiting Team	Home Team	X	Visiting Team	Home Team	X	Visiting Team
TUE 23	1	1 EGY	AWA	5 RSA	4 REU	x	1 EGY	1 EGY	x	3 MOR	1 EGY	x	3 MOR
	2	4 REU	AWA	6 KEN	3 MOR	x	5 RSA	2 TUN	x	4 REU	2 TUN	x	4 REU
	3	3 MOR	AWA	2 TUN	2 TUN	x	6 KEN	6 KEN	x	5 RSA	6 KEN	x	5 RSA
R.R (03)		Match (05), 09H00				RR(03), Match (01), 12H30				Match (02), 15H15			
Date	Table No.	Home Team	X	Visiting Team	Home Team	X	Visiting Team	Home Team	X	Visiting Team	Home Team	X	Visiting Team
WED 24	1	2 TUN	x	1 EGY	1 Team R 01	x	6 Team R 06	5 Team R 05	x	1 Team R 01	5 Team R 05	x	1 Team R 01
	2	6 KEN	x	3 MOR	2 Team R 02	x	5 Team R 05	6 Team R 06	x	4 Team R 04	6 Team R 06	x	4 Team R 04
	3	5 RSA	x	4 REU	3 Team R 03	x	4 Team R 04	2 Team R 02	x	3 Team R 03	2 Team R 02	x	3 Team R 03
R.R (03)		Match (03), 09H00				Match (04), 12H30				Match (05), 15H15			
Date	Table No.	Home Team	X	Visiting Team	Home Team	X	Visiting Team	Home Team	X	Visiting Team	Home Team	X	Visiting Team
THU 25	1	1 Team R 01	x	4 Team R 04	3 Team R 03	x	1 Team R 01	1 Team R 01	x	2 Team R 02	1 Team R 01	x	2 Team R 02
	2	5 Team R 05	x	3 Team R 03	4 Team R 04	x	2 Team R 02	3 Team R 03	x	6 Team R 06	3 Team R 03	x	6 Team R 06
	3	6 Team R 06	x	2 Team R 02	5 Team R 05	x	6 Team R 06	4 Team R 04	x	5 Team R 05	4 Team R 04	x	5 Team R 05

The Semi-final and Final schedule on Friday 26th and Saturday 27th of May will be published later.





Roster - Open Teams

Egypt
Captain Ahmed Zayed
Wael Adel
Raafat El Sayyad
Ahmed Hussein
Motaz Fouda
Sherif Noshy
Moaz Hammam
Kenya
Captain Bhanumati Shah
Samina Ismail
Ramula Shah
Samina Esmail
Saleem Ud Deen
Aruna Shah
Chandrakant V Shah
Morocco
Captain Fatim Lahlou
Mohammed Adnane Ammor
Ismail Chamar
Stephane Dahan
Fatim Lahlou
Pierre Sibony

Reunion
Captain Patrick Hamel
Patrick Hamel
Christian Giraud
Gabriel Melin
Jean-Luc Neulat
Catherine Aouate
Régine Wan Hoi
South Africa
Captain Hennie Fick
Neville Eber
Hennie Fick
Alon Apteker
Craig Gower
Bernard Donde
Robert Stephens
Tunisia
Captain Hassouna Ben Abdelmalek
Skander Touil
Ahmed Meddeb
Anis Ghodhbane
Mohamed Ali Lakhdhar
Omar Meddeb
Lassad Jedidi





12th African Bridge Championships



GMT TIME

Open Teams Schedule of play

Each Match = 16 Boards in 2H 15min

R.R (01)		Match (01), 09H00			Match (02), 12H30			Match (03), 15H15		
Date	Table No.	Home Team	X	Visiting Team	Home Team	X	Visiting Team	Home Team	X	Visiting Team
SUN 28	1	1 EGY	x	6 KEN	5 REU	x	1 EGY	1 EGY	x	4 TUN
	2	2 RSA	x	5 REU	6 KEN	x	4 TUN	5 REU	x	3 MOR
	3	3 MOR	x	4 TUN	2 RSA	x	3 MOR	6 KEN	x	2 RSA
R.R (01)		Match (04), 09H00			Match (05), 12H30			RR(02) Match (01), 15H15		
Date	Table No.	Home Team	X	Visiting Team	Home Team	X	Visiting Team	Home Team	X	Visiting Team
MON 29	1	3 MOR	x	1 EGY	1 EGY	x	2 RSA	6 KEN	x	1 EGY
	2	4 TUN	x	2 RSA	3 MOR	x	6 KEN	5 REU	x	2 RSA
	3	5 REU	x	6 KEN	4 TUN	x	5 REU	4 TUN	x	3 MOR
R.R (02)		Match (02), 09H00			Match (03), 12H30			Match (04), 15H15		
Date	Table No.	Home Team	X	Visiting Team	Home Team	X	Visiting Team	Home Team	X	Visiting Team
TUE 30	1	1 EGY	x	5 REU	4 TUN	x	1 EGY	1 EGY	x	3 MOR
	2	4 TUN	x	6 KEN	3 MOR	x	5 REU	2 RSA	x	4 TUN
	3	3 MOR	x	2 RSA	2 RSA	x	6 KEN	6 KEN	x	5 REU
R.R (03)		Match (05), 09H00			RR(03), Match (01), 12H30			Match (02), 15H15		
Date	Table No.	Home Team	X	Visiting Team	Home Team	X	Visiting Team	Home Team	X	Visiting Team
WED 31	1	2 RSA	x	1 EGY	1 Team R 01	x	6 Team R 06	5 Team R 05	x	1 Team R 01
	2	6 KEN	x	3 MOR	2 Team R 02	x	5 Team R 05	6 Team R 06	x	4 Team R 04
	3	5 REU	x	4 TUN	3 Team R 03	x	4 Team R 04	2 Team R 02	x	3 Team R 03
R.R (03)		Match (03), 09H00			Match (04), 12H30			Match (05), 15H15		
Date	Table No.	Home Team	X	Visiting Team	Home Team	X	Visiting Team	Home Team	X	Visiting Team
THU 01	1	1 Team R 01	x	4 Team R 04	3 Team R 03	x	1 Team R 01	1 Team R 01	x	2 Team R 02
	2	5 Team R 05	x	3 Team R 03	4 Team R 04	x	2 Team R 02	3 Team R 03	x	6 Team R 06
	3	6 Team R 06	x	2 Team R 02	5 Team R 05	x	6 Team R 06	4 Team R 04	x	5 Team R 05

The Semi-final and Final schedule on Friday 2nd and Saturday 3rd of June will be published later.





Roster - Women Teams

Egypt

Captain
Dina El Awady
Nada Wattar
Catherine Pascal
Hoda Soliman
Marguerite Homsy
Nada Moussa

Kenya

Captain
Bijal Shah
Bijal Shah
Punam Shah
Samira Dedhia Soni
Rupal shah
Sejal Shah
Vimla Virjee

Morocco

Captain
Hayat Hachimi
Hayat Hachimi
Leila Kabbaj
Samira Teber
Graziella Nabil
Leila Benmlih
Khadija Marrakchi

South Africa

Captain
Roz Bernstein
Roz Bernstein
Sharon Lang
Vanessa Armstrong
Carol Stanton
Nicky Bateman
Tas Nestoridis

Tunisia

Captain
Mohamed Rebai
Ferdaous Trabelsi
Maissa Farhani
Hedia Sellami
Jalila Ghodhbane
Meriem Daldoul
Aicha Daldoul





12th African Bridge Championships



GMT TIME

Women Teams Schedule of play

Each Match = 16 Boards in 2H 15min

R.R {01}		Match {01}, 09H00			Match {02}, 12H30			Match {03}, 15H15		
Date	Table No.	Home Team	X	Visiting Team	Home Team	X	Visiting Team	Home Team	X	Visiting Team
SUN 28	1	1 EGY	x	6 BYE	5 KEN	x	1 EGY	1 EGY	x	4 TUN
	2	2 RSA	x	5 KEN	6 BYE	x	4 TUN	5 KEN	x	3 MOR
	3	3 MOR	x	4 TUN	2 RSA	x	3 MOR	6 BYE	x	2 RSA
R.R {01}		Match {04}, 09H00			Match {05}, 12H30			RR{02} Match {01}, 15H15		
Date	Table No.	Home Team	X	Visiting Team	Home Team	X	Visiting Team	Home Team	X	Visiting Team
MON 29	1	3 MOR	x	1 EGY	1 EGY	x	2 RSA	6 BYE	x	1 EGY
	2	4 TUN	x	2 RSA	3 MOR	x	6 BYE	5 KEN	x	2 RSA
	3	5 KEN	x	6 BYE	4 TUN	x	5 KEN	4 TUN	x	3 MOR
R.R {02}		Match {02}, 09H00			Match {03}, 12H30			Match {04}, 15H15		
Date	Table No.	Home Team	X	Visiting Team	Home Team	X	Visiting Team	Home Team	X	Visiting Team
TUE 30	1	1 EGY	x	5 KEN	4 TUN	x	1 EGY	1 EGY	x	3 MOR
	2	4 TUN	x	6 BYE	3 MOR	x	5 KEN	2 RSA	x	4 TUN
	3	3 MOR	x	2 RSA	2 RSA	x	6 BYE	6 BYE	x	5 KEN
R.R {03}		Match {05}, 09H00			RR{03}, Match {01}, 12H30			Match {02}, 15H15		
Date	Table No.	Home Team	X	Visiting Team	Home Team	X	Visiting Team	Home Team	X	Visiting Team
WED 31	1	2 RSA	x	1 EGY	1 Team R 01	x	6 Team R 06	5 Team R 05	x	1 Team R 01
	2	6 BYE	x	3 MOR	2 Team R 02	x	5 Team R 05	6 Team R 06	x	4 Team R 04
	3	5 KEN	x	4 TUN	3 Team R 03	x	4 Team R 04	2 Team R 02	x	3 Team R 03
R.R {03}		Match {03}, 09H00			Match {04}, 12H30			Match {05}, 15H15		
Date	Table No.	Home Team	X	Visiting Team	Home Team	X	Visiting Team	Home Team	X	Visiting Team
THU 01	1	1 Team R 01	x	4 Team R 04	3 Team R 03	x	1 Team R 01	1 Team R 01	x	2 Team R 02
	2	5 Team R 05	x	3 Team R 03	4 Team R 04	x	2 Team R 02	3 Team R 03	x	6 Team R 06
	3	6 Team R 06	x	2 Team R 02	5 Team R 05	x	6 Team R 06	4 Team R 04	x	5 Team R 05

The Semi-final and Final schedule on Friday 2nd and Saturday 3rd of June will be published later.





RealBridge Playing Instructions

First : Log in , Lobby, at the table and Settings

1. To join any RealBridge game you will need a **LINK**

2. All the play links will be available on ABF website

https://www.bridgewebs.com/cgi-bin/bwop/bw.cgi?club=abf&pid=display_page24

AND you might also receive it by mail.

3. Click the link and you will be redirected to the log on page of our game which looks like the next figure ...

Notice that your video should appear in the right bottom corner of the page and mic volume showing that it works.

4. If you can't see your video then you need to allow your browser to use your cam and mic, do as follows to allow it

5. From Goggle Chrome and just before the address bar, press the lock icon

6. Allow cam and allow mic.

7. Write your name in the required field and press login – nothing else is to be done- **NO ID number will be used, (leave it blank)**

8. When you logged in you will see the lobby which almost looks like the following figure (**but this figure includes extra buttons for TDs**)

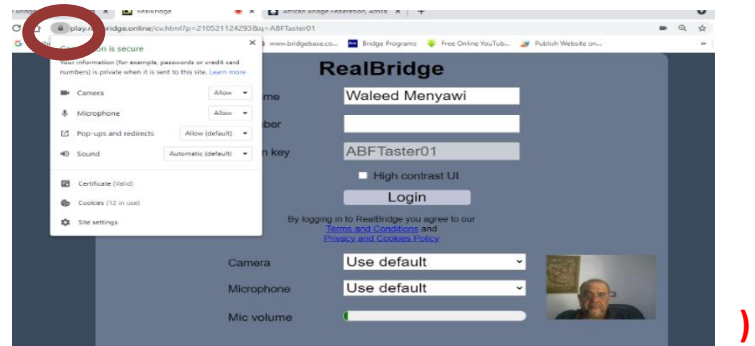
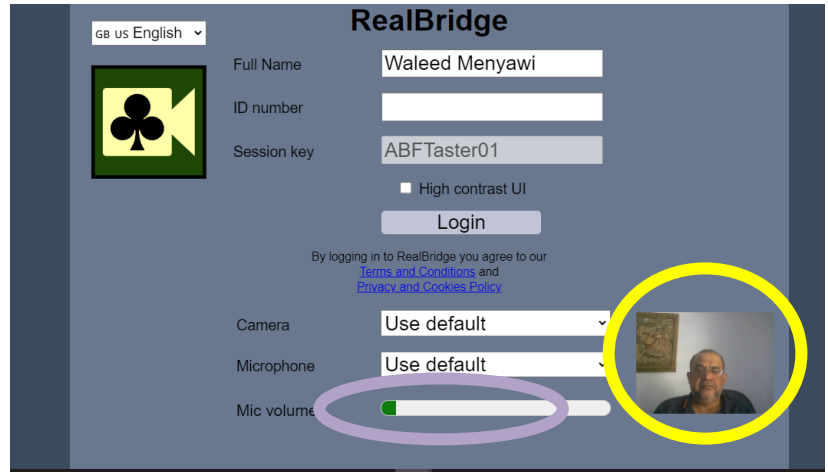

Notice the lobby chat window to the right.

**Keep an eye to the Lobby chat ...
- For important announcements**

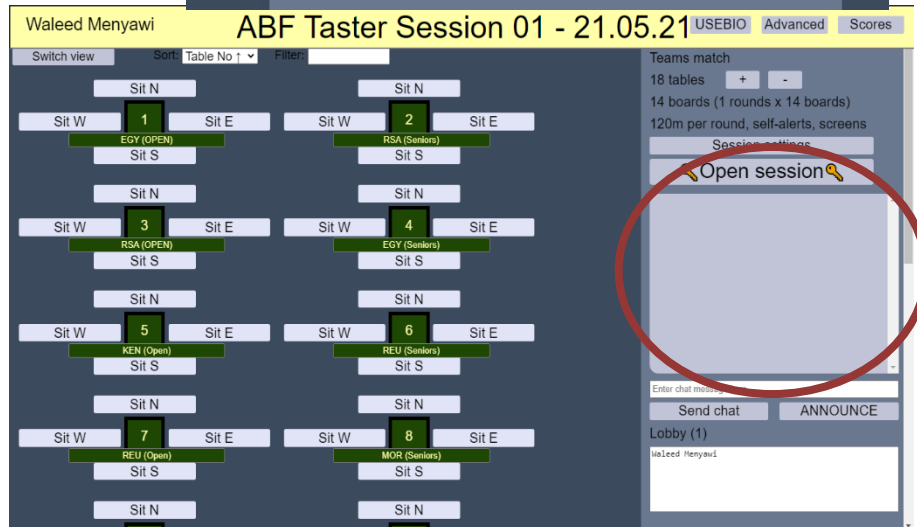



9. Each table labeled with a team name, find your table and chose where to sit (Sit N, Sit S, Sit E or Sit W)

10. Get familiar with the buttons at your table and call the TD using the button for help.

Volume control for your partner.

Volume control for left-hand opponent. You have a separate volume control for each player. This only affects what you hear.

Private chat with left-hand opponent. You can chat privately only with the opponents, not partner

Volume control for right-hand opponent.

Private chat with right-hand opponent.

Disable/enable your video.

Disable / enable your microphone. Use this when you're on the phone!

Hide / unhide the other players' videos. Use this if you have a poor connection.

Redial. Restarts audio and video connections. Use it if the connection fails, or if your video or audio gets out of sync.

Settings

Display style

- Detailed cards
- Simplified cards

As defender, see dummy

- Facing declarer
- Facing me

As declarer, see dummy as

- Vertical suits (facing declarer)
- Horizontal hand

Input style

- One click or tap
- Two taps (tablet)
- Double click (mouse)

Deal animation

Slide

Animation duration

OK Cancel

"Detailed cards" shows pictures of cards; "Simplified cards" are schematic and have larger symbols

The orientation of dummy's cards when you are defending.

The orientation of dummy's cards when you are declaring.

Choose the way you make bids and plays. With "Two taps", the first tap selects the card, then the second tap confirms. "Double click" means that you make two fast clicks.

This controls how a new hand arrives at the beginning of each deal. Choose an effect, or set to "None" to have the hand simply appear.

If you have an animation enabled, use the slider to control how long the animation lasts.





11. After we play all boards

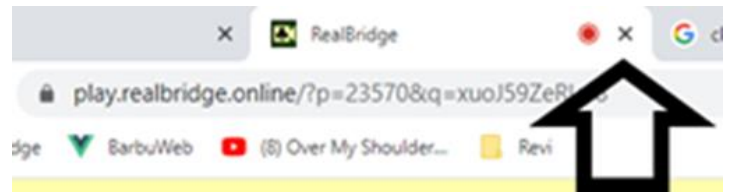

Leave RealBridge, close the tab. See the small X? just click it.



12. Can Use and Can't use

Can Use	Can't use
<ul style="list-style-type: none"> • Windows laptop • Windows desktop • MacBook or another Apple laptop • iMac or another Apple desktop • Chromebook 	<ul style="list-style-type: none"> • Smartphone • Old iPads, older than 2018.

You must use one of these web browsers (you probably are using one of them!):

Can Use ü	Can't use û
<p>Edge, Chrome, Firefox, Safari. The logo must look like one of these – exactly as below. If it looks different, you are using an out-of-date version. <i><u>If you are choosing amongst your browsers, we advise that you chose something other than Firefox.</u></i></p>	<p>Internet Explorer (notice the gold band) The old EDGE (see shape of the e)</p>
	

Second : Bidding, Play, Alert and System

13. **At the start** of any session, All the team members are required to be seated at the same table (Table with the **team name label**), the system will automatically move the EW pairs to the opponents table when we start the session **and will send them back to their home table when both tables finish playing the boards.**

14. **Private chat and Table chat**

- It is strongly recommended to use the chat rather than the vocal chat; the TDs will not take into consideration any vocal explanation if you have any case.
- I will show you now, 2 figures and will appoint to you where to find the table chat (where the 4 players can see your chat) and where to find the private chat where you can chat privately with one of your opponents (not your partner of-course 😊).



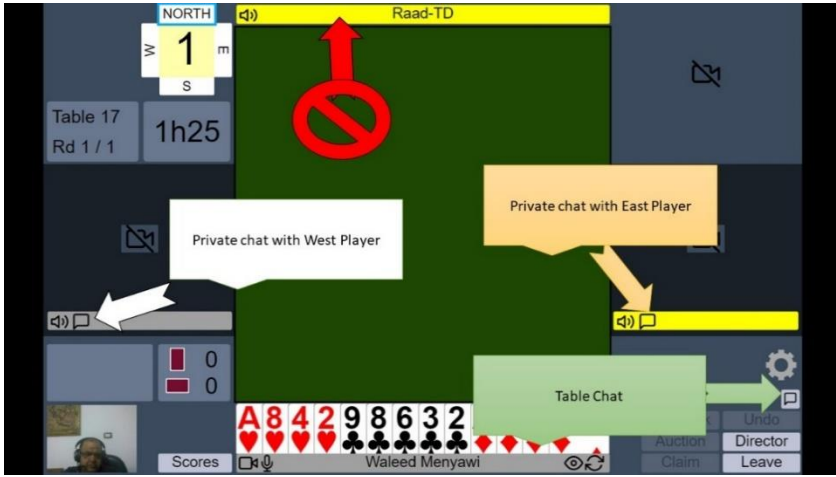

When you are at Full Screen mode

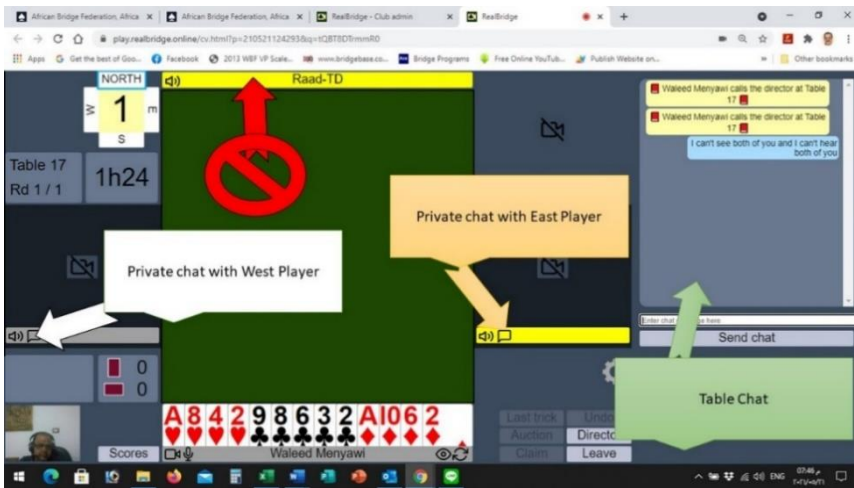

When you are at normal view (NOT Full Screen mode

15. Self-alert and self-explanation proper procedure:

1. Click alert (if required)
2. Write / Put in explanation
3. Make bid

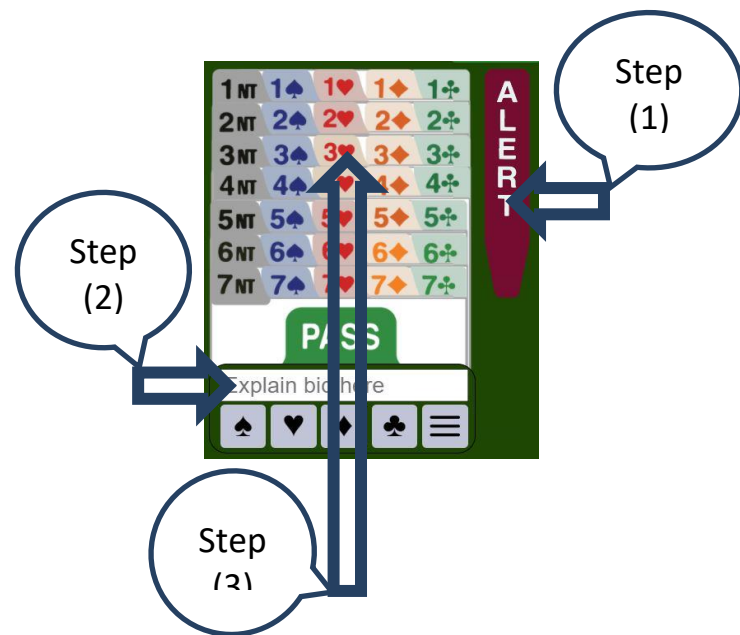



If you make a **mistake** or need to **explain your bid further** after you have bid, you can click on the bid and add more text.

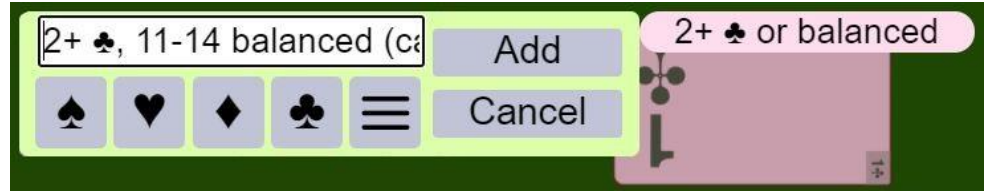

The added text will appear after an asterisk *. The time in seconds between when the bid was **made** and the added explanation was **submitted** is presented after the added text in the square brackets, for this example, 26 seconds. The character limit on explanations is 200 characters.

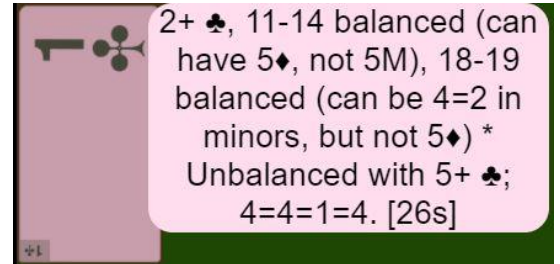

16. System

All teams are required to write a brief about their system at the table chat box before the start of first board in each match.

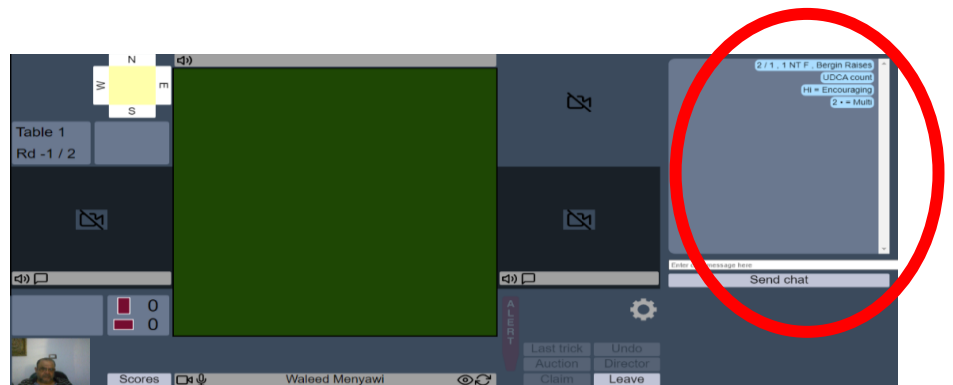



Un Message d'Accueil de Votre Président, Bernard Pascal

Chers compétiteurs, chers Officiels, chers amis,

Une chaleureuse bienvenue à ces 12^{èmes} championnats de la Zone 8 lesquels se dérouleront sur la plateforme « RealBridge »

Au nom de l'équipe de Direction ABF (Chafika Taktak, Helen Kruger, Samina Esmail et Jean-Claude Cador) je témoigne ma profonde reconnaissance à vous tous (joueurs et NBOs) pour nous avoir apporté tout le soutien nécessaire à l'organisation de cet événement continental, pour la deuxième fois, en ligne

Pour nous tous, en Zone 8, 2023 laissera une marque indélébile dans l'histoire de bridge de notre continent. Pour la première fois depuis la création de notre Zone, les championnats du monde sont organisés sur notre cher continent, dans l'accueillante ville de Marrakech au Maroc. Et pas n'importe quelle compétition puisqu'il s'agit de la reine de toutes les compétitions : les championnats du monde par équipe dans les quatre catégories. Cela étant dit, et pour rendre à César ce qui est à César, ce sera la deuxième fois que cette même compétition se déroule sur notre continent ; Hammamet, Tunisie avait abrité les championnats du monde par équipes il y a environ 26 ans, en 1997 et ce fût un grand succès.



Au nom de la Zone 8, je souhaite exprimer ma gratitude envers le Comité exécutif de la WBF, à son Président sortant, **Gianarrigo Rona** ainsi qu'à notre nouveau Président, **Jan Kamras**, pour avoir confié au Maroc l'organisation de cet événement mondial.

En conséquence de ce qui précède, trois équipes (pays) accèdent, cette année, à la phase finale des championnats du monde, dans chaque catégorie : le Maroc, pays organisateur et deux autres équipes africaines – quelle grande opportunité pour nous, et pour la première fois, tout en espérant qu'elle soit renouvelée.

J'en profite pour mentionner le Président de la Fédération Royale Marocaine, Mr **Abdellatif Belkouch**, et son équipe, pour avoir accepté d'inscrire les quatre équipes marocaines à nos éliminatoires de Zone alors qu'elles sont qualifiées d'office pour Marrakech. J'espère sincèrement que la participation des quatre équipes leur offrira une solide préparation aux championnats du monde.

Et puisque nous évoquons Marrakech, nous en profitons pour exprimer notre profonde gratitude à Mme **Chafika Taktak**, Présidente du Comité d'organisation local des championnats du monde laquelle, épaulée par son équipe, travaille inlassablement pour faire de cet événement un grand succès. Merci Chafika et merci à toute l'équipe marocaine.

Notre chef Arbitre et Directeur des opérations, notre cher « Joker », **Waleed El Menyawi**, nous confortera en orchestrant, une fois de plus, les éliminatoires de la Zone 2023. Merci, cher Waleed, pour ton dévouement continu à la Zone 8.





A partir de ce bulletin, et tous les bulletins successifs, vous pourrez lire, quotidiennement, les mises à jour, les résultats, les analyses et bien d'autres informations concernant le déroulement des épreuves et, tout ceci, grâce à **Ron Tacchi** qui vous les concoctera.

Demain, nous inaugurons ces championnats par le traditionnel « Open par Paires » que nous avons dû modifier en raison du faible nombre de participants. Par conséquent, nous jouerons trois séances (une Vendredi à 11H am GMT et deux Samedi à 10H am et à 2H30 pm GMT). Et comme je participerai à cette épreuve, j'éprouverai tant de plaisir à rencontrer chaque compétiteur et vous souhaiter la bienvenue personnellement. Assurez-vous d'être parmi les six premiers afin de recevoir les prix offerts par l'ABF.

Enfin, je m'adresse à toutes les équipes : vous êtes sur le point de vous confronter aux meilleurs talents de notre continent et je vous souhaite de bien vous battre, de gagner et, surtout, de vous faire plaisir. Je suis impatient de féliciter les équipes qui se qualifieront pour Marrakech à la fin de la première semaine, en Seniors et en Mixte, puis, à la fin de la deuxième semaine, en Dames et en Open.

Bon vent à toutes et à tous et merci de nous offrir votre meilleur niveau, de la haute compétitivité et, le tout, dans une ambiance amicale à laquelle vous nous avez toujours habitués

Bernard Pascal

