

African Bridge Federation



13th ♠♥♦♣

African Bridge Championships

Online - 2025

From April 27th To May 10th



RealBridge

Bulletin 3

Wednesday 30th April

Editor Ron Tacchi

Halfway Through the Round Robins

Today we pass the halfway mark in the Round Robin segment of these two championships and we have clear leaders. There was little change in the standings but Morocco and South Africa swapped places in both competitions.

In the Mixed Championship **Egypt** and **Tunisia** are clear at the top, the interest is the contest for the other two semi-final berths between **South Africa**, **Morocco** and **Reunion**.

In the Seniors the gap between the leaders, **Egypt** has narrowed and **South Africa** has now taken the second spot ahead of **Morocco** and **Reunion**.

Standings

| Mixed Team | VPs | Position |
|--------------|---------------|----------|
| Egypt | 131.69 | 1 |
| Tunisia | 115.53 | 2 |
| South Africa | 87.44 | 3 |
| Morocco | 81.19 | 4 |
| Reunion | 70.31 | 5 |
| Kenya | 53.34 | 6 |

| Senior Team | VPs | Position |
|--------------|---------------|----------|
| Egypt | 122.62 | 1 |
| Morocco | 113.44 | 2 |
| South Africa | 95.76 | 3 |
| Reunion | 85.93 | 4 |
| Kenya | 50.25 | 5 |

For all information use QR Code
or the website:

www.bridgewebs.com/abf/





Schedule for Wednesday 30th April

Note all times are GMT

Senior Championship

| R.R (03) | | Match (05), 09H00 | | | RR(03),Match (01), 12H30 | | | Match (02), 15H30 | | |
|-------------------------|-----------|-------------------|---|---------------|--------------------------|---|---------------|-------------------|---|---------------|
| Date | Table No. | Home Team | X | Visiting Team | Home Team | X | Visiting Team | Home Team | X | Visiting Team |
| WED 30 | 1 | 2 EGY | x | 1 MOR | 1 RANK 01 | x | 6 RANK 06 | 5 RANK 05 | x | 1 RANK 01 |
| | 2 | 6 -- | x | 3 RSA | 2 Rank 02 | x | 5 RANK 05 | 6 RANK 06 | x | 4 RANK 04 |
| | 3 | 5 KEN | x | 4 REU | 3 RANK 03 | x | 4 RANK 04 | 2 Rank 02 | x | 3 RANK 03 |

Mixed Championship

| R.R (03) | | Match (05), 09H00 | | | RR(03),Match (01), 12H30 | | | Match (02), 15H30 | | |
|-------------------------|-----------|-------------------|---|---------------|--------------------------|---|---------------|-------------------|---|---------------|
| Date | Table No. | Home Team | X | Visiting Team | Home Team | X | Visiting Team | Home Team | X | Visiting Team |
| WED 30 | 4 | 2 TUN | x | 1 EGY | 1 RANK 01 | x | 6 RANK 06 | 5 RANK 05 | x | 1 RANK 01 |
| | 5 | 6 KEN | x | 3 RSA | 2 Rank 02 | x | 5 RANK 05 | 6 RANK 06 | x | 4 RANK 04 |
| | 6 | 5 REU | x | 4 MOR | 3 RANK 03 | x | 4 RANK 04 | 2 Rank 02 | x | 3 RANK 03 |

Results

Mixed Championship

| Session 1 | VPs |
|------------------------|------------|
| Egypt - Reunion | 16.73-3.27 |
| Morocco - Kenya | 7.45-12.55 |
| South Africa - Tunisia | 2.55-17.45 |
| Session 2 | |
| Morocco- Egypt | 1.91-18.09 |
| South Africa - Reunion | 18.44-1.56 |
| Tunisia - Kenya | 15-5 |
| Session 3 | |
| Egypt - South Africa | 10.31-9.69 |
| Tunisia - Morocco | 11.48-8.52 |
| Kenya - Reunion | 0-20 |

Senior Championship

| Session 1 | VPs |
|------------------------|------------|
| Morocco - Kenya | 19.69-0.31 |
| Reunion - Bye | 12-0 |
| South Africa - Egypt | 11.76-8.24 |
| Session 2 | |
| Reunion - Morocco | 10-10 |
| South Africa - Kenya | 13.97-6.03 |
| Egypt - Bye | 12-0 |
| Session 3 | |
| Morocco - South Africa | 18.33-1.67 |
| Egypt - Reunion | 17.72-2.28 |
| Bye - Kenya | 0-12 |





Morocco vs. South Africa - Mixed

The final session of the second day in the Mixed Championship was the first session of the second Round Robin. Morocco who are bubbling around third place in the standings were pitted against South Africa who were on their tail and would hope to bypass them after this match.

Board 36. Dealer West. All Vul.

| | | | | | | |
|------------------------------------|--|---|---------|---|------------------------------------|-----------------------------------|
| ♠ Q103 ♥ AQ86 ♦ 62 ♣ KQ85 | <table style="margin: auto; border: 1px solid black; background-color: #008000; color: white; padding: 5px;"> <tr><td style="padding: 2px;">N</td></tr> <tr><td style="padding: 2px;">W E</td></tr> <tr><td style="padding: 2px;">S</td></tr> </table> | N | W E | S | ♠ KJ96 ♥ 1074 ♦ 43 ♣ J976 | ♠ A54 ♥ J93 ♦ AQJ87 ♣ 32 |
| N | | | | | | |
| W E | | | | | | |
| S | | | | | | |
| | ♠ 872 ♥ K52 ♦ K1095 ♣ A104 | | | | | |

Open Room

| West | North | East | South |
|----------------|-------------------|---------------|--------------|
| <i>Rosslee</i> | <i>Abderrahim</i> | <i>Hingle</i> | <i>Fatim</i> |
| 1♣ | Pass | 1♦ | Pass |
| 1NT | Pass | 3NT | All Pass |

With little to go on North made the unfortunate lead of the ♥10, thereby giving declarer four tricks in the suit. A losing diamond finesse ensued and South continued the heart attack which was won in hand. The ace and queen of diamonds was cashed and another played another to South. At his point both South and West fell from grace, but the two actions cancelled each other out. West discarded a winning heart and South when winning the diamond cashed the ace of clubs, giving declarer two tricks in the suit and thus nine tricks. When declarer discarded a winning heart South needs to switch to a spade. West's correct discard is a club. If South now switches to a spade declarer ducks in both hands and now North either leads a club setting up the ninth trick or a spade runs round to the queen, either way the game is made.

Closed Room

| West | North | East | South |
|---------------|---------------|----------------|--------------|
| <i>Bitton</i> | <i>Kaprey</i> | <i>ClosedE</i> | <i>Weers</i> |
| 1♣ | Pass | 1♦ | Pass |
| 1♥ | Pass | 2NT | Pass |
| 3NT | All Pass | | |

Yet again the defence started with a heart, conceding four easy tricks in the suit and the loss of a tempo. Winning in hand declarer took a winning heart finesse followed by a losing diamond finesse. Spurning the contract defeating switch to a spade for reasons only apparent to South the king of hearts was led, Winning in dummy declarer played three rounds of diamonds but in a desperate effort to hand back control to the defence discarded a spade from dummy. Now South finally found the switch to a spade and declarer ducked but North continued with the king pinning dummy's queen and setting up his ♠9 and so now declarer failed by one trick. To beat the contract legitimately South needs to lead a black card. It is self evident of the success of a spade but I will leave the reader to work out why the less obvious club attack breaks the contract. The game of ping-pong resulted in 12 IMPs for South Africa





13th African Bridge Championships



Board 39. Dealer South. All Vul.

| | | |
|---------|--|----------|
| ♠ 76 | | |
| ♥ A5 | | |
| ♦ AKJ72 | | |
| ♣ K943 | | |
| ♠ 982 | | ♠ K53 |
| ♥ J742 | | ♥ Q63 |
| ♦ 5 | | ♦ Q1043 |
| ♣ QJ752 | | ♣ A108 |
| | | ♠ AQJ104 |
| | | ♥ K1098 |
| | | ♦ 986 |
| | | ♣ 6 |



Open Room

| West | North | East | South |
|---------|------------|----------|-------|
| Rosslee | Abderrahim | Hingle | Fatim |
| - | - | - | 1♠ |
| Pass | 2♦ | Pass | 2♥ |
| Pass | 3♣ | Pass | 3♦ |
| Pass | 3NT | All Pass | |

South demonstrated how light opening bids are these days, and I have no problem with it. The auction reached the optimum contract and received the lead of ♥3, covered by the jack and ace. A successful spade finesse was followed by a losing diamond finesse. East continued, to no avail, the heart attack and dummy's ♥9 held the trick and a diamond was the entry to hand, Declarer now staked everything on the spade finesse, how I wish I had been West and had held the ♠K and had ducked smoothly on the play of spades, but it was a wish too far. The kind distribution of the spades and the felling of the ♥Q meant declarer had two overtricks.

Closed Room

| West | North | East | South |
|--------|-----------|----------|-------|
| Bitton | Kaprey | ClosedE | Weers |
| - | - | - | 1♠ |
| Pass | 2♦ | Pass | 2♥ |
| Pass | 2NT | Pass | 3♦ |
| Pass | 4♦* | Pass | 4♥ |
| Pass | 4♠* | Pass | 4NT* |
| Pass | 6♦ | All Pass | |
| 4♦ | minorwood | | |
| 4♠ | ♦Q ask | | |
| 4NT | No queen | | |

Not a great slam: requiring the diamonds to come in without loss and the spade finesse to succeed, well under 25% and as we can see the trump suit was more than unkind and so declarer had the solace of knowing had they stopped in the minor-suit

game it also would have failed. 13 IMPs to Morocco

Board 40. Dealer West. None Vul.

| | | |
|----------|--|---------|
| ♠ 873 | | |
| ♥ Q92 | | |
| ♦ 875 | | |
| ♣ 9854 | | |
| ♠ A92 | | ♠ KQ106 |
| ♥ 83 | | ♥ J1054 |
| ♦ KJ1063 | | ♦ A92 |
| ♣ KQ10 | | ♣ J6 |
| | | ♠ J54 |
| | | ♥ AK76 |
| | | ♦ Q4 |
| | | ♣ A732 |



Open Room

| West | North | East | South |
|---------|------------------------|--------|-------|
| Rosslee | Abderrahim | Hingle | Fatim |
| 1♦ | Pass | 1♥ | Pass |
| 1NT* | Pass | 2♠* | Pass |
| 3NT | All Pass | | |
| 2♠ | 44 majors invitational | | |

As we know in the modern game all invitational bids are game forcing and West was up to the challenge. The opening lead of the ♣8 was taken by South who returned the suit and dummy's jack took the trick. The ace of diamonds followed by another produced the queen and five tricks in the suit and when the spades behaved kindly declarer had eleven tricks.

Closed Room

| West | North | East | South |
|--------|----------|---------|-------|
| Bitton | Kaprey | ClosedE | Weers |
| 1♦ | Pass | 1♥ | Pass |
| 1NT | Pass | 2NT | Pass |
| 3NT | All Pass | | |

By not mentioning her spades East induced a spade lead taken in hand. Declarer now played a diamond to the ♦9, not the textbook approach, and when it lost to the queen the defence took their four top tricks in the round suits for one off. 11 IMPs to South Africa, Can you spot the one card North has to lead to ensure the defeat of the contract? The answer is the nine of hearts, I do not expect to find many cases of that being the opening lead.





13th African Bridge Championships



Board 47. Dealer South. N/S Vul.

| | | | | | | |
|------------|---|----------|---|---|---|-----|
| ♠ A4 | | ♠ 8 | | | | |
| ♥ 105 | | ♥ A932 | | | | |
| ♦ KQ1074 | | ♦ 52 | | | | |
| ♣ QJ102 | | ♣ A98765 | | | | |
| ♠ QJ109762 | <table border="1" style="background-color: #008000; color: white; text-align: center; width: 40px; height: 40px;"> <tr><td>N</td></tr> <tr><td>W</td></tr> <tr><td>E</td></tr> <tr><td>S</td></tr> </table> | N | W | E | S | ♠ 8 |
| N | | | | | | |
| W | | | | | | |
| E | | | | | | |
| S | | | | | | |
| ♥ QJ74 | ♥ A932 | | | | | |
| ♦ J8 | ♦ 52 | | | | | |
| ♣ — | ♣ A98765 | | | | | |
| | ♠ K53 | | | | | |
| | ♥ K86 | | | | | |
| | ♦ A963 | | | | | |
| | ♣ K43 | | | | | |

Open Room

| West | North | East | South |
|----------------|-------------------|---------------|--------------|
| <i>Rosslee</i> | <i>Abderrahim</i> | <i>Hingle</i> | <i>Fatim</i> |
| — | — | — | 1♦ |
| 3♠ | 3NT | Pass | Pass |
| 4♥ | Pass | Pass | Double |
| 4♠ | 5♦ | All Pass | |

West led the queen of spades taken in dummy, trumps were drawn and spades eliminated, a club from dummy saw East rise with his ace and play a heart. Declarer had the choice of two lines, one no chance and the other, a slim chance. The no chance line was taken when a small heart was played from hand, so now the defence had two heart tricks. I agree it is highly likely the ♥A is with West but what does it cost to rise with the ♥K? The answer is nothing and in this case a game is made.

Closed Room

| West | North | East | South |
|---------------|---------------|----------------|--------------|
| <i>Bitton</i> | <i>Kaprey</i> | <i>ClosedE</i> | <i>Weers</i> |
| — | — | — | 1♦ |
| 3 | 5♦ | All Pass | |

A much simpler auction to the same contract, declarer won in dummy and drew trumps in two rounds and then led a club from dummy whereupon Esat rose with her ace and now cashed the ace of hearts solving all declarer's problems. The game was now duly made. Another 'What lead beats it' question. The answer is a small heart which goes to partner's ace and since this cannot be a singleton partner should try the ace of clubs and then give partner the game-busting club ruff.

A match where both teams can go back and say 'we could have done better' saw South Africa squeeze out a very narrow win 41-39 or 10.61-9.39 VPs,

Dear Captains

Please pay full attention

As I received several complains about failure to alert a conventional bid by players and these complains were supported by photos against many teams.

Kindly be advised that all the conventional/artificial bids have to be alerted with fully disclosed- even if from the player's point of view it is clear

Double / Redouble / 4 NT / responses to 4NT / Transfers / Stayman / Puppet etc. as long as these bids are artificial or conventional, they must be alerted.

It has been decided that failure to do this, may result in your team receiving a penalty of 0.25 VP even if no clear damage was done.

Please, Please – Share with your team as soon as you read this





Tunisia vs. Reunion - Mixed

At the end of the second day the other Mixed championship match was between Tunisia and Reunion. After the completion of the first Round Robin Reunion were lying outside the top four and remaining there they would not be competing for a place at the World Bridge Team Championships in Herning.

Board 35. Dealer South. E/W Vul.

| | | | | | |
|------------------------------------|--|------------------------------------|---------|---|-------------------------------------|
| ♠ A975 ♥ A32 ♦ AQ ♣ KQ53 | <table style="margin: auto; border: 1px solid black; background-color: #008000; color: white; padding: 5px;"> <tr><td style="padding: 2px;">N</td></tr> <tr><td style="padding: 2px;">W E</td></tr> <tr><td style="padding: 2px;">S</td></tr> </table> | N | W E | S | ♠ K84 ♥ 9764 ♦ 1097 ♣ 1074 |
| N | | | | | |
| W E | | | | | |
| S | | | | | |
| ♠ Q106 ♥ KJ8 ♦ KJ432 ♣ A9 | | ♠ J32 ♥ Q105 ♦ 865 ♣ J862 | | | |

Open Room

| West | North | East | South |
|--------------|---------------|----------------|-----------------|
| <i>Boyer</i> | <i>Halima</i> | <i>Schilli</i> | <i>Lakhdhar</i> |
| - | - | - | Pass |
| 1♦ | Double | Pass | 1♥ |
| Pass | 2NT | Pass | 3NT |
| All Pass | | | |

According to the convention card a direct overcall of 1NT shows 15-18 so a Double followed by a no-trump bid would be 18-19 and so a 2NT rebid would be at least 20+ and I assume that was South's interpretation. The ♦10 lead ran round to dummy's queen and I was at a loss to see how declarer had any chance of success. Declarer tackled clubs and West took the second round and cleared the diamond suit, Declarer now cashed his two club tricks whereupon West broke one of those rules I learnt at my mother's knee of discarding losers and keeping winners as she discarded two diamonds. Declarer now led a spade from dummy, West interjecting the ♠10 and declarer taking the ace before exiting with a spade to West who refused to take the winning diamond and instead set up declarer's ninth trick by continuing spades.

Closed Room

| West | North | East | South |
|------------------|---------------|------------------|-----------------|
| <i>Goncalves</i> | <i>Neulat</i> | <i>Ghodhbane</i> | <i>Bauquier</i> |
| - | - | - | Pass |
| 1NT | All Pass | | |

I suggest one's methods of dealing with an opening 1NT needs some work on it if it means you pass with the North hand. Do not ask me how, but somehow, with a little help from his friends, West amassed seven tricks and his contract. 10 IMPs to Tunisia.

Board 38. Dealer East. E/W Vul.

| | | | | | |
|-----------------------------------|--|-------------------------------------|---------|---|------------------------------------|
| ♠ KQ4 ♥ KQ ♦ J6 ♣ KQJ653 | <table style="margin: auto; border: 1px solid black; background-color: #008000; color: white; padding: 5px;"> <tr><td style="padding: 2px;">N</td></tr> <tr><td style="padding: 2px;">W E</td></tr> <tr><td style="padding: 2px;">S</td></tr> </table> | N | W E | S | ♠ A82 ♥ AJ108 ♦ 98 ♣ A872 |
| N | | | | | |
| W E | | | | | |
| S | | | | | |
| | | ♠ 763 ♥ 93 ♦ KQ1072 ♣ 1094 | | | |
| | | ♠ J1095 ♥ 76542 ♦ A543 ♣ - | | | |

Open Room

| West | North | East | South |
|--------------|---------------|----------------|-----------------|
| <i>Boyer</i> | <i>Halima</i> | <i>Schilli</i> | <i>Lakhdhar</i> |
| - | - | 1♣ | Pass |
| 2♣* | 2♦ | 3♣ | 5♦ |
| 6♣ | Pass | Pass | 6♦ |
| Double | All Pass | | |
| 2♣ | SMI 12+ | | |

Five Diamonds was boyh a brave and a good bid – it was par. But both him and West went to the well once too often. West was in the well-known bind that his side should at the five-level or in the grand slam, because if they find their diamond tricks you have eleven, if they do not you have thirteen tricks. The defence calmly took their five top tricks for four off.





13th African Bridge Championships



Closed Room

| West | North | East | South |
|------------------|---------------|------------------|-----------------|
| <i>Goncalves</i> | <i>Neulat</i> | <i>Ghodhbane</i> | <i>Bauquier</i> |
| - | - | 1♣ | Pass |
| 2♣* | Pass | 2♥ | Pass |
| 2♠ | Pass | 3♣ | Pass |
| 4♣* | Pass | 4♥* | Pass |
| 6♣ | All Pass | | |
| 4♣ | RKCB | | |
| 4♥ | 3 keycards | | |

I could find no explanation for the 2♣ bid but I assume it was SMI and after a series of cue-bids blackwood was launched and found three keycards-but unfortunately none of them were in diamonds. South led the ace of diamonds on which North played the ♦10, I would have played the king showing the queen so not giving South a chance to go wrong but South was up to the task and continued with another diamond, so one off. 14 IMPs to Reunion.

Board 42. Dealer East. All Vul.

| | | | |
|---------|-----------|----------|--|
| | ♠ 10 | | |
| | ♥ AKQJ754 | | |
| | ♦ 7 | | |
| | ♣ KJ74 | | |
| ♠ KJ2 | | ♠ 543 | |
| ♥ 10863 | | ♥ 92 | |
| ♦ J94 | | ♦ AK1085 | |
| ♣ 652 | | ♣ Q98 | |
| | ♠ AQ9876 | | |
| | ♥ - | | |
| | ♦ Q632 | | |
| | ♣ A103 | | |

Open Room

| West | North | East | South |
|--------------|---------------|----------------|-----------------|
| <i>Boyer</i> | <i>Halima</i> | <i>Schilli</i> | <i>Lakhdhar</i> |
| - | - | Pass | 1♠ |
| Pass | 2♥ | Pass | 2♠ |
| Pass | 4♥ | All Pass | |

There does not seem to be an easy way of getting any higher and declarer's task was made easier when East led the ace of diamonds and switched to a club, so now twelve tricks were available.

Closed Room

| West | North | East | South |
|------------------|---------------|------------------|-----------------|
| <i>Goncalves</i> | <i>Neulat</i> | <i>Ghodhbane</i> | <i>Bauquier</i> |
| - | - | Pass | 1♠ |
| Pass | 2♥* | Pass | 2♠ |
| Pass | 3♥ | Pass | 3♠ |
| Pass | 4♣ | Pass | 4♠ |
| Pass | 4NT | Pass | 5♠ |
| Pass | 6♥ | All Pass | |
| 2♥ | Game forcing | | |

With Two Hearts being game forcing West could temporise with Three Hearts and eventually when it became apparent that two aces were opposite went for the heart slam. The defence started with the ace and king of diamonds, declarer ruffing the second round and then played all of the trumps bar one and then elected to finesse against East in the club suit and so brought home the slam. 13 IMPs to Reunion.

Board 43. Dealer South. None Vul.

| | | | |
|--------|---------|----------|--|
| | ♠ A9762 | | |
| | ♥ J82 | | |
| | ♦ 432 | | |
| | ♣ K10 | | |
| ♠ KQ84 | | ♠ 10 | |
| ♥ 973 | | ♥ AK1054 | |
| ♦ AK5 | | ♦ J10 | |
| ♣ AJ8 | | ♣ 97654 | |
| | ♠ J53 | | |
| | ♥ Q6 | | |
| | ♦ Q9876 | | |
| | ♣ Q32 | | |

Open Room

| West | North | East | South |
|--------------|---------------|----------------|-----------------|
| <i>Boyer</i> | <i>Halima</i> | <i>Schilli</i> | <i>Lakhdhar</i> |
| - | - | - | Pass |
| 1NT | Pass | 2♦ | Double |
| 2♥ | 2♠ | 3♠ | Pass |
| 4♥ | All Pass | | |

South must have been very pleased that his partner led a diamond in response to his Double (the point of which I am uncertain) as it immediately set up an extra trick for declarer. Upon taking the diamond lead declarer cashed two top trumps and the ten of diamonds and played a small club to the jack and queen and now when North cashed his ace of spades and master trump declarer had the rest of the tricks for her game.





13th African Bridge Championships



Closed Room

| West | North | East | South |
|------------------|---------------|------------------|-----------------|
| <i>Goncalves</i> | <i>Neulat</i> | <i>Ghodhbane</i> | <i>Bauquier</i> |
| - | - | - | Pass |
| 1NT | Pass | 2♦ | Pass |
| 2♥ | Pass | 3♣ | Pass |
| 4♥ | All Pass | | |

Declarer won the opening diamond lead in hand and then played a small heart to ♥10 which lost to the queen and now South switch to a small spade and declarer's queen lost to the ace and a diamond was the continuation taken in dummy, Then the ♣9 ran round to North's ♣10 and another diamond was used as an exit card. Declarer tried valiantly by cashing the ♠K and ruffing another and then leading the last trump but South kept two clubs and North the master spade and a club so the defence took the last trick for one off. 10 IMPs to Reunion.

In a match with only one flat board Reunion sneaked the victory 47-44 or 10.91-9.09 VPs.

47th WORLD BRIDGE TEAMS CHAMPIONSHIPS 14th WORLD TRANSNATIONAL OPEN TEAMS

Herning, Denmark • 20 - 31 August, 2025*

*Registration and Opening Ceremony on 19 August





Morocco vs. Kenya - Seniors

The first match on day three of the Round Robins Morocco faced Kenya in the Seniors Championships. Morocco were third in the standings but a good win here could see them overtake South Africa only three points ahead

Board 3. Dealer South. E/W Vul.

| | | | |
|-------------------------------------|--|-----------------------------------|------------------------------------|
| ♠ 105 ♥ K1097 ♦ KJ5 ♣ A843 | <div style="display: flex; justify-content: space-between; align-items: center;"> N W E S </div> | ♠ J984 ♥ AJ5 ♦ AQ73 ♣ Q5 | ♠ A73 ♥ 43 ♦ 642 ♣ J10972 |
| ♠ KQ62 ♥ Q862 ♦ 1098 ♣ K6 | | | |

Open Room

| West | North | East | South |
|-------------|----------------|---------------|--------------|
| <i>Deen</i> | <i>Berrada</i> | <i>Virjee</i> | <i>Hayat</i> |
| - | - | - | Pass |
| Pass | 1♦ | Pass | 1♥ |
| Pass | 1♠ | Pass | 3♠ |
| Pass | 4♠ | All Pass | |

The ♣10 was led to the ace, a small heart returned which ran round to dummy's ♥8. The ♦10 held the next trick and when the suit was continued West covered with his king and declarer took the ace. Trumps were now tackled with a small one towards dummy's king which held the trick, a second round was taken by East and now with the aid of the heart finesse and the kind position in diamonds declarer had the rest of the tricks for plus one.

Closed Room

| West | North | East | South |
|-------------------|-------------|-----------------|---------------|
| <i>Cambournac</i> | <i>Shah</i> | <i>Belkouch</i> | <i>Esmail</i> |
| - | - | - | Pass |
| Pass | 1♦ | Pass | 1♠ |
| Double | 3♠ | Pass | 4♠ |
| All Pass | | | |

When South decided to bid spades rather than hearts we had the same contract but played from a different hand. West led the ♥10 and declarer rose with dummy's ace, a trump to hand won and second round was taken by East who promptly switched back to a heart taken by his partner's king and another led for East to ruff and take the contract down. 11 IMPs to Morocco.

Board 4. Dealer West. All Vul.

| | | | |
|------------------------------------|--|------------------------------------|------------------------------------|
| ♠ AK10943 ♥ AJ73 ♦ 72 ♣ 7 | <div style="display: flex; justify-content: space-between; align-items: center;"> N W E S </div> | ♠ Q762 ♥ K94 ♦ Q95 ♣ J105 | ♠ J5 ♥ Q1052 ♦ K84 ♣ K642 |
| ♠ 8 ♥ 86 ♦ AJ1063 ♣ AQ983 | | | |

Open Room

| West | North | East | South |
|-------------|----------------|---------------|--------------|
| <i>Deen</i> | <i>Berrada</i> | <i>Virjee</i> | <i>Hayat</i> |
| 1♠ | Pass | 1NT | Pass |
| 2♥ | Pass | 3♥ | Pass |
| 4♥ | All Pass | | |

1NT was not alerted but I believe from the convention card that it is forcing and if so fully explains the bidding. North elected to lead a slightly deceptive small trump which was won by dummy's ♥10. When the lead of the jack of spades failed to provoke a cover declarer rose with the ace. Now when declarer tried to cash the king of spades South ruffed in and now declarer had no chance as the cards lie but in trying to make the contract declarer caused more undertricks and was eventually three off.





13th African Bridge Championships



Closed Room

| West | North | East | South |
|-------------------|-------------|-----------------|---------------|
| <i>Cambournac</i> | <i>Shah</i> | <i>Belkouch</i> | <i>Esmail</i> |
| 1♠ | Pass | 1NT* | 2♣ |
| 2♥ | 3♣ | 3♥ | Pass |
| 4♥ | Pass | Pass | 5♣ |
| Double | All Pass | | |

West cashed his ace of spades and then switched to a diamond, dummy's ♦9 being covered by the king and ace. A small diamond towards the queen held the next trick and by way of repeated finesses trumps were drawn. All declarer now needed to do was to lead towards dummy's king of hearts to generate the eleventh and game going trick. 10 IMPs to Kenya

Board 7. Dealer South. All Vul.

| | |
|----------|--------|
| ♠ QJ9 | |
| ♥ J9874 | |
| ♦ K943 | |
| ♣ 10 | |
| ♠ K103 | ♠ A854 |
| ♥ 2 | ♥ KQ |
| ♦ A85 | ♦ QJ62 |
| ♣ KJ9542 | ♣ A86 |
| ♠ 762 | |
| ♥ A10653 | |
| ♦ 107 | |
| ♣ Q73 | |

Open Room

| West | North | East | South |
|-------------|----------------|---------------|--------------|
| <i>Deen</i> | <i>Berrada</i> | <i>Virjee</i> | <i>Hayat</i> |
| - | - | - | Pass |
| Pass | Pass | 1NT | Pass |
| 2♠ | Pass | 3♣ | Pass |
| 4NT | Pass | 5♥ | Pass |
| 6♣ | All Pass | | |

West appears to me to have been a trifle overenthusiastic in his evaluation of his hand. East could not have had a lot more, yes there are perfect hands which would enable the slam to succeed, but just imagine if the ace of clubs was the ace of hearts. The slam is incredibly poor but there some distributions to allow it to make (not many). South cashed his ace of hearts and switched to a diamond and declarer had no choice but to let it run do North took the king. A laterwrong choice in the trump suit meant a two trick set.

Closed Room

| West | North | East | South |
|-------------------|-------------|-----------------|---------------|
| <i>Cambournac</i> | <i>Shah</i> | <i>Belkouch</i> | <i>Esmail</i> |
| - | - | - | Pass |
| 1♣ | Pass | 1♦ | Pass |
| 2♣ | Pass | 2♠ | Pass |
| 3♦ | Pass | 3NT | All Pass |

South's heart lead went to partner's jack and declarer's king. Declarer cashed the ace and king of clubs and played a third round to South's queen. South now played a small heart to declarer's immense relief as he now took his remaining top tricks for plus one. Should South have tried the ace of hearts? I think the answer is yes. If we go back to the bidding he seems to have suggested four cards in diamonds and spades and has shown up with three clubs so I will leave you to decide how many hearts you think are in the East hand. 11 IMPs to Morocco.

Board 10. Dealer East. All Vul.

| | | |
|----------|-----|---------|
| ♠ A1042 | | ♠ 986 |
| ♥ 6432 | | ♥ 85 |
| ♦ 74 | | ♦ KQ108 |
| ♣ J86 | | ♣ KQ43 |
| ♠ J5 | ♠ N | |
| ♥ KQJ109 | W | E |
| ♦ 9532 | S | |
| ♣ 97 | | |
| ♠ KQ73 | | |
| ♥ A7 | | |
| ♦ AJ6 | | |
| ♣ A1052 | | |

Open Room

| West | North | East | South |
|-------------|----------------|---------------|--------------|
| <i>Deen</i> | <i>Berrada</i> | <i>Virjee</i> | <i>Hayat</i> |
| - | - | Pass | 1♣ |
| 1♥ | 1♠ | Pass | 4♠ |
| All Pass | | | |

Declarer took the opening heart lead in dummy and played a small club towards hand, with West playing the ♣9 and declarer's jack falling to the king. A heart was won by West who played another round ruffed in dummy. Declarer now made the strange play of ace and another club. West ruffed this and East obviously did not realise that a trump had been played and contributed the queen. Another heart was perforce ruffed in dummy but declarer had the good fortune to see the jack of spades fall so could overtake the second round of trumps and





13th African Bridge Championships



draw the last one with the ♠10 before crossing to dummy to cash the now surprisingly good ♣10 for the contract. If this had been a Shakespearean play it would have been entitled 'A comedy of errors'.

Closed Room

| West | North | East | South |
|-------------------|-------------|-----------------|---------------|
| <i>Cambournac</i> | <i>Shah</i> | <i>Belkouch</i> | <i>Esmail</i> |
| - | - | Pass | 1♣ |
| Pass | 1♥ | Pass | 2NT |
| All Pass | | | |

A contract that is certain to succeed as East has only two hearts and so West can never get in to cash the heart winners but I assume an error as South led a small diamond from hand and West was awake enough to rise with the ♦9 and cash hearts tricks to defeat the contract. 12 IMPs to Morocco.

Board 13. Dealer North. All Vul.

| | | |
|---------|----------|----------|
| ♠ K8 | | ♠ J3 |
| ♥ AJ9 | | ♥ 108432 |
| ♦ 963 | | ♦ AK107 |
| ♣ QJ754 | | ♣ 83 |
| ♠ 1094 | ♠ N | ♠ J3 |
| ♥ KQ765 | ♥ W | ♥ 108432 |
| ♦ 842 | ♦ E | ♦ AK107 |
| ♣ K9 | ♣ S | ♣ 83 |
| | ♠ AQ7652 | |
| | ♥ - | |
| | ♦ QJ5 | |
| | ♣ A1062 | |

Open Room

| West | North | East | South |
|-------------|----------------|---------------|--------------|
| <i>Deen</i> | <i>Berrada</i> | <i>Virjee</i> | <i>Hayat</i> |
| - | Pass | Pass | 1♠ |
| Pass | 2♣* | Pass | 4♠ |
| All Pass | | | |
| 2♣ | Landy | | |

I am not sure what Landy is supposed to mean in this situation. West led the king of hearts taken by dummy's ace, declarer discarding a diamond. Trumps were drawn in three rounds and now declarer just played ace and another club to ensure ten tricks.

Closed Room

| West | North | East | South |
|-------------------|-------------|-----------------|---------------|
| <i>Cambournac</i> | <i>Shah</i> | <i>Belkouch</i> | <i>Esmail</i> |
| - | Pass | Pass | 1♠ |
| Pass | 2NT | Pass | 3♠ |
| All Pass | | | |

What can South do over the 2NT response, anything other than Three Spades could lead to disaster, at least Three Spades should generate a plus score, which of course it did, unfortunately more plus than one would wish. The problem with bidding systems is that they are not perfect, if there was a perfect bidding system we would all be playing it. 10 more IMPs to Morocco.

Board 15. Dealer South. N/S Vul.

| | | |
|----------|----------|--------|
| ♠ K10653 | | ♠ J974 |
| ♥ AQ | | ♥ 953 |
| ♦ 98 | | ♦ K42 |
| ♣ AJ98 | | ♣ 1065 |
| ♠ 2 | ♠ N | ♠ J974 |
| ♥ K64 | ♥ W | ♥ 953 |
| ♦ AQ653 | ♦ E | ♦ K42 |
| ♣ Q743 | ♣ S | ♣ 1065 |
| | ♠ AQ8 | |
| | ♥ J10872 | |
| | ♦ J107 | |
| | ♣ K2 | |

Open Room

| West | North | East | South |
|-------------|----------------|---------------|--------------|
| <i>Deen</i> | <i>Berrada</i> | <i>Virjee</i> | <i>Hayat</i> |
| - | - | - | 1♥ |
| 2♦ | 2♠ | 3♦ | 3♠ |
| 4♦ | 4♠ | Pass | Pass |
| 5♦ | Double | All Pass | |

Yes Four Spades is a make but why would West think Five Diamonds was a good save. Could it be that East supported his diamonds with an eleven loser hand? North led a trump, normally the correct thing to do in such bidding. Declarer was without resource and the defence declined to be helpful so the result was five down,

Closed Room

| West | North | East | South |
|-------------------|-------------|-----------------|---------------|
| <i>Cambournac</i> | <i>Shah</i> | <i>Belkouch</i> | <i>Esmail</i> |
| - | - | - | Pass |
| 1♦ | 1♠ | Pass | 3♠ |
| Pass | 4♠ | All Pass | |

The defence played three rounds of diamonds, declarer ruffing the third. Declarer at some point took the heart finesse and played on cross ruff lines for a competent completion of the game contract. 10 IMPs to Morocco.

Morocco ran out winners 81-25 or 19.69-0.31 VPs.





Kenya vs. Tunisia - Mixed

The third session of the second Round Robin marks the halfway point to find the four semi-finalists who will play to win a place at the world championships, Kenya take on Tunisia, and Kenya are in danger of losing touch with the premier quartet, so must do well here.

Board 18. Dealer East. N/S Vul.

| | | | | | |
|----------|---|---|-----|---|-------|
| ♠ AQ98 | <table border="1"> <tr><td>N</td></tr> <tr><td>W E</td></tr> <tr><td>S</td></tr> </table> | N | W E | S | ♠ J73 |
| N | | | | | |
| W E | | | | | |
| S | | | | | |
| ♥ K10732 | ♥ J5 | | | | |
| ♦ Q74 | ♦ J9862 | | | | |
| ♣ 4 | ♣ 1052 | | | | |
| ♠ K54 | | | | | |
| ♥ 96 | | | | | |
| ♦ 53 | | | | | |
| ♣ AJ8763 | | | | | |

Open Room

| West | North | East | South |
|--------|---------|----------|-------|
| Halima | Stanley | Lakhdhar | Sejal |
| - | - | Pass | Pass |
| 1♥ | 1NT | All Pass | |

I have checked the convention card and checked North's points and the 1NT is 15-17 and I am pretty sure North has 18 points. Even if I think partner has 15-17 then with the South hand I am going to bid 2NT with my eight count and six good clubs. Declarer was not going to fail in this contract! At the end twelve tricks were taken for the unusual score of 240-one you want to write frequently in your column.

Closed Room

| West | North | East | South |
|----------|-----------|---------|---------|
| R. Shah | Ghodhbane | P. Shah | Fourati |
| - | - | Pass | Pass |
| 1♥ | 1NT | Pass | 3NT |
| All Pass | | | |

South was made of sterner stuff than his opposite number and had no compunction in going for the vulnerable game. Suffice it to say that declarer was not tested in the play and rapidly gathered eleven tricks and 9 IMPs to Tunisia.

Board 19. Dealer South. E/W Vul.

| | | | | | |
|---------|---|---------|-----|---|-------|
| ♠ QJ74 | <table border="1"> <tr><td>N</td></tr> <tr><td>W E</td></tr> <tr><td>S</td></tr> </table> | N | W E | S | ♠ 853 |
| N | | | | | |
| W E | | | | | |
| S | | | | | |
| ♥ J64 | ♥ AQ53 | | | | |
| ♦ 3 | ♦ J9862 | | | | |
| ♣ QJ963 | ♣ 10 | | | | |
| ♠ AK962 | | ♠ 10 | | | |
| ♥ 97 | | ♥ K1082 | | | |
| ♦ KQ105 | | ♦ A74 | | | |
| ♣ A2 | | ♣ K8754 | | | |

Open Room

| West | North | East | South |
|--------|----------|----------|--------|
| Halima | Stanley | Lakhdhar | Sejal |
| - | - | - | Pass |
| 1♠ | Pass | 2♠ | Double |
| Redble | 3♣ | 4♠ | 5♣ |
| Double | All Pass | | |

Sometimes the urge to bid overcomes reason, I am not entirely happy with South's Double, if you pass and West passes there is a good possibility that North will find some balancing bid, but if West is a strong hand you maybe inflicting serious pain on your side. I believe that North's Three Clubs shows nothing other than he would rather play in clubs than hearts, which I think is a very accurate description of his hand. Five Clubs can only be described as a brave bid, which in bulletin speak is a harsh comment. As can be seen Four Spades is not laydown and West had a much stronger hand than his initial opening promised and yet game is not assured. Five clubs finished up down two.

Closed Room

| West | North | East | South |
|----------|--------------|---------|---------|
| R. Shah | Ghodhbane | P. Shah | Fourati |
| - | - | - | Pass |
| 1♠ | Pass | 1NT* | Pass |
| 2♦ | Pass | 2♠ | Double |
| All Pass | | | |
| 1NT* | semi-forcing | | |

North's pass of the Double is not the bid I would have made, but then I probably would not have





13th African Bridge Championships



doubled with the South hand, just goes to show what an old fossil I am. The green card was not a success, Whilst on normal play the contract has an overtrick, North kept ruffing with his master trumps allowing an extra overtrick for the pleasant score of 1070. 13 IMPs to Kenya.

Board 22. Dealer East. E/W Vul.

| | | | |
|------------------------------------|--|-------------------------------------|-----------------------------------|
| ♠ 62 ♥ J10984 ♦ A92 ♣ J86 | <div style="display: flex; justify-content: space-between; align-items: center;"> N W E S </div> | ♠ J107 ♥ A52 ♦ K1083 ♣ 932 | ♠ 954 ♥ 63 ♦ J764 ♣ K754 |
| ♠ AKQ83 ♥ KQ7 ♦ Q5 ♣ AQ10 | | | |

Open Room

| West | North | East | South |
|---------------|----------------|-----------------|--------------|
| <i>Halima</i> | <i>Stanley</i> | <i>Lakhdhar</i> | <i>Sejal</i> |
| – | – | Pass | 2♣* |
| Pass | 2♦ | Pass | 2♠ |
| Pass | 3♠ | Pass | 4♣ |
| Pass | 4♦ | Pass | 4♠ |
| All Pass | | | |
| 2♣ | 21-22 | | |

My finessing friend tells me that twelve tricks are possible but it requires you to play for trebleton ♦9 on your left and jack to four diamonds on you right. If you got that right then you might be on someone's database for 'unusual' play. Declarer made the expected eleven tricks.

Closed Room

| West | North | East | South |
|----------------|------------------|----------------|----------------|
| <i>R. Shah</i> | <i>Ghodhbane</i> | <i>P. Shah</i> | <i>Fourati</i> |
| – | – | Pass | 2♣* |
| Pass | 2♥* | Pass | 2♠ |
| Pass | 3♠ | Pass | 4♣ |
| Pass | 4♦ | Pass | 4NT* |
| Pass | 5♦ | Pass | 6♠ |
| All Pass | | | |

2♣ alerted as strong hand not necessarily clubs, but convention card 23+ game forcing.

Two Hearts was alerted but no explanation given, one assumes it showed an ace, especially as the 4NT bid was alerted as asking for kings.

Declarer took the opening heart lead in hand and took two rounds of trumps finishing in dummy to lead a diamond to his queen and West's ace. West made no mistake and carried on with the hearts. Declarer drew the last trump and tried a diamond to the ♦10 but when East produced the jack he was down. 11 IMPs to Kenya.

Board 27. Dealer South. None Vul.

| | | | |
|-------------------------------------|--|-------------------------------------|-----------------------------------|
| ♠ KQ9 ♥ 2 ♦ AJ107 ♣ AQJ82 | <div style="display: flex; justify-content: space-between; align-items: center;"> N W E S </div> | ♠ J10863 ♥ KQJ93 ♦ – ♣ K65 | ♠ A52 ♥ 7 ♦ KQ8432 ♣ 974 |
| ♠ 74 ♥ A108654 ♦ 965 ♣ 103 | | | |

Open Room

| West | North | East | South |
|---------------|----------------|-----------------|--------------|
| <i>Halima</i> | <i>Stanley</i> | <i>Lakhdhar</i> | <i>Sejal</i> |
| – | – | – | 2♥ |
| Double | 4♥ | 5♦ | Pass |
| 6♦ | 6♥ | Pass | Pass |
| Double | All Pass | | |

The question is should North take insurance with Six Hearts, I fear the answer is not black and white – obviously when we see all 52 cards we know the answer is no, If you are thinking of going to Six Hearts then maybe a bid of Five Hearts rather than Four would put maximum pressure on the opponents – starting bidding at the six-level is not easy and may well result in some error – in effect make them roll the dice. The contract finished the obvious two off.

Closed Room

| West | North | East | South |
|----------------|------------------|----------------|----------------|
| <i>R. Shah</i> | <i>Ghodhbane</i> | <i>P. Shah</i> | <i>Fourati</i> |
| – | – | – | Pass |
| 1♣ | 2♦* | 3♦ | 3♥ |
| 4♣ | 4♥ | 5♣ | 5♥ |
| 6♣ | All Pass | | |
| 2♦ | majors | | |

I am not exactly sure why West failed to support partner's diamonds and South showed remarkable restraint when it was known that partner held five hearts. Six Clubs was not a success. Declarer





13th African Bridge Championships



allowed the defence to ruff a spade and a diamond and that along with a heart trick and the king of clubs was three off. 10 IMPs to Reunion.

Board 29. Dealer North. All Vul.

| | | |
|-----------|----------|-----------|
| ♠ KQ10543 | | ♠ 2 |
| ♥ 764 | | ♥ AKQ1095 |
| ♦ AJ | | ♦ 1072 |
| ♣ J10 | | ♣ 943 |
| ♠ AJ6 | | |
| ♥ 3 | | |
| ♦ KQ8543 | | |
| ♣ A62 | | |
| | W | E |
| | N | S |
| | | |
| ♠ 987 | | |
| ♥ J82 | | |
| ♦ 96 | | |
| ♣ KQ875 | | |

Open Room

| West | North | East | South |
|---------------|----------------|-----------------|--------------|
| <i>Halima</i> | <i>Stanley</i> | <i>Lakhdhar</i> | <i>Sejal</i> |
| - | 1♠ | 2♥ | 2♠ |
| 3NT | All Pass | | |

On the lead of the king of spades declarer ducked as in the classic Bath Coup but North continued with another spade won with declarer's jack. With the kind split in the heart suit declarer was soon claiming eleven tricks.

Closed Room

| West | North | East | South |
|----------------|------------------|----------------|----------------|
| <i>R. Shah</i> | <i>Ghodhbane</i> | <i>P. Shah</i> | <i>Fourati</i> |
| - | 1♠ | 2♥ | 2♠ |
| All Pass | | | |

West is still waiting for East's protective bid but a direct bid of 3NT might have served a lot better, the scant good news is that the contract was defeated by one trick but still 11 IMPs to Tunisia.

Board 31. Dealer South. N/S Vul.

| | | |
|----------|----------|----------|
| ♠ J10643 | | ♠ K7 |
| ♥ 632 | | ♥ KJ |
| ♦ KJ9 | | ♦ Q532 |
| ♣ 94 | | ♣ Q10875 |
| ♠ A | | |
| ♥ AQ1097 | | |
| ♦ A6 | | |
| ♣ AKJ62 | | |
| | W | E |
| | N | S |
| | | |
| ♠ Q9852 | | |
| ♥ 854 | | |
| ♦ 10874 | | |
| ♣ 3 | | |

Open Room

| West | North | East | South |
|---------------|----------------|-----------------|--------------|
| <i>Halima</i> | <i>Stanley</i> | <i>Lakhdhar</i> | <i>Sejal</i> |
| - | - | - | Pass |
| 2♣* | Pass | 2♦* | Pass |
| 2♥ | Pass | 3♣ | Pass |
| 3♠ | Pass | 4NT | Pass |
| 5♦ | Pass | 6NT | All Pass |

I can find no explanation of the 3♠ bid and also no reason for not playing in the club fit. We can all see that there are thirteen top tricks in clubs, hearts and no-trumps. Declarer may have had a frisson of disappointment when he saw dummy.

Closed Room

| West | North | East | South |
|----------------|---------------------------------|----------------|----------------|
| <i>R. Shah</i> | <i>Ghodhbane</i> | <i>P. Shah</i> | <i>Fourati</i> |
| - | - | - | Pass |
| 2♦* | Pass | 2♥* | Pass |
| 3♣* | Pass | 3NT | All Pass |
| 2♦ | weak multi or strong two-suiter | | |
| 2♥ | pass or correct | | |
| 3♣ | strong hand clubs and hearts | | |

This hand does not make me want to play the multi Two Diamonds. I do not know how strong 'strong' is when West bids like this but I suspect it would be as a minimum in the 20 point range, if so then East needs to do more, especially as he knows he has a 5-5 fit. Declarer had the unenviable task of writing 540 on his scorecard. 11 more IMPs to Tunisia. As football parlance goes - 'it was a game of two halves'. Kenya were doing well over the first eight boards but conceded 48 points in the last seven deals. Tunisia had finished winners by 56-36 or 15-5 in VPs.





Championship Information

Your Chief Tournament Director Waleed El Menyawi explains the important procedures to be observed during the Championships:

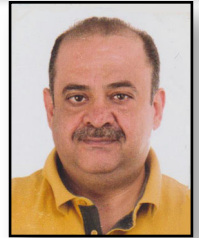

The Followings are some important information from your Head TD which need to be carefully read by each member, captain or coach of any team, please refer to the [Conditions of Contest](#) for full details.

1. Play Format: Open, Women, Seniors & Mixed teams

1. Three Complete RR (15 Matches X 16 Boards each; in 5 days)
2. The top four teams will qualify to the Semi-final stage, the first ranked team will choose its opponents from between teams ranked 3rd or 4th.
3. Semi-Final will be five Segments of 16 Boards each, No Carry Over (Check the [CoC](#) for tie-breaks).
4. For the Semi-final, Final and play-off sessions, It has been decided that:
5. - The team ranked higher after the RR stage will be the Home team in segments 3 & 5 in the Semi-final.
6. - The team ranked lower after the RR stage will be the Home team in segments 2 & 4 in the Semi-Final.
7. - The 1st Segment will be blind line up.
8. - The team ranked higher after the RR stage will be the Home team in segment 3 in the Final or Play-off.
9. - The team ranked lower will be the Home team in Segment 2 while segment 1 will be blind.
10. The Final will be three Segments of 14 Boards each, No Carry Over (Check the [CoC](#) for tie-breaks).
11. The first 2 RR will be home and away line-ups.
12. The last Round Robin shall be done according to the final ranking of the teams in the previous played 2 rounds and will be a blind line-up.

2. Teams Events ... Last RR

The last Round Robin for all categories shall be done according to the final ranking of the teams in the previous played rounds.

3. Please click the link below for instructions

[Alert Procedures - Undo Procedures - General Instructions](#)

Note that : « Systems Policy Change: Please note that as of January 1st 2025 the use of a written defence against the Multi 2 Diamonds (or 2 Clubs) is no longer permitted in WBF events

5. Play instructions and Schedule of play ...

A. When you log on to the RealBridge game (using the game link), you will find your team





name written in one of the Tables.

B. All team members are required to sit at their table (all together) in Pairs NS and EW, later on, when we start the session, the software will automatically move the EW pairs between the tables according to the schedule of play.

C. In the schedule of play you will find Home team (the team mentioned first) and Visiting team (the team mentioned second)

D. The visiting team has to sit first at their table (Pairs NS and EW) and the Home team has the right to have a look at the visiting team and sit its pairs accordingly.

6. Request a review

1. First step is to review the TD ruling with the Head TD

2. Second step is apply for an official review by submitting a review form through the TD in charge of your case.

3. A request for a review of a Tournament Director's ruling must be lodged within 30 minutes of the first posting of the official score for the Session in which the board was played that is the subject of the ruling. All such requests must be lodged by the team's Captain or his designee, or by one member of the pair in the Pairs events.

4. When lodging a Request for Review the appellant must make a monetary deposit with the ABF monitor. The amount of deposit required will be US \$ 100 (or the equivalent in Euro)

5. The case will be reviewed by a person who was not involved in the original decision. The Reviewer will check that the TD has gathered the necessary evidence of what occurred when the infraction arose. The Reviewer will then need to be satisfied that the correct law was applied and that other TDs were consulted where appropriate. In matters involving the judgement that was exercised by a player following unauthorized information, incorrect explanation or failure to alert, the Reviewer will clarify that suitable players have been asked appropriate questions to enable a judgmental view to be obtained. Finally, the Reviewer will check that the ruling that was issued based upon all the information available to the TDs was within the bounds of reasonableness. The fact that the Reviewer might have determined a slightly different ruling would not be good reason for the ruling to be varied. In the event that the process had not been followed properly in some material way, the Reviewer will ask the Head TD to correct the failings and issue a new ruling.

7. Time delay and hesitation

- It is very important to know that the TDs have the tools to produce a board report which includes the time for each bid / play by each player, so please be bare that in mind when calling the TD for a possible hesitation or before denying it.

- It is also very important to know that the TDs also have the tools to produce a session time report which includes the exact time taken by each player in a session, in case of time delay, the penalty will be given according to this report.

8. Home & Visiting teams

- When you log in to the RealBridge game (using the game link), you will find your team name written on one of the Tables.
- All team members are required to sit at their table (all together) in Pairs NS and EW, later on, when we start the session, the software will automatically move the EW pairs between the tables according to the schedule of play.





13th African Bridge Championships



- In the schedule of play you will find Home team (the team mentioned first) and Visiting team (the team mentioned second)
- NO LINE-UP will be needed from the teams, the visiting team has to sit first at their table (in Pairs NS and EW), minimum 10 min before the official start time, and the Home team has the right to have a look at the visiting team and sit its pairs accordingly.

9. Headphones / Earphones

In order to minimize the noise in the venue as much as possible...

- It is mandatory for each player to have his own headphone / earphone which is connected to his device during play
- Use the table chat / private chat as much as possible and don't use vocal chat.
- Any vocal explanation will not be taken into the TD consideration in any case.
- You need to be very careful when using the table chat as you might give an unauthorized information to your partner which could results in adjusted score by the TD.

10. Kibitzers

- Kibitzers are not allowed by any means at 1) the playing venue, 2) RealBridge online playing room.
- All players are required to immediately leave the playing area when they finish their session, players are also kindly asked to keep their seats and not roam around the playing area.
- All the matches will be broadcasted via RealBridge kibitzer website...

<https://kibitz.realbridge.online/>

- At the RealBridge kibitzer website, you can find the live broadcasted matches and also all the other matches scheduled for broadcast.
- For security reasons, all broadcasted matches will be delayed by 30-45 min.

11. Smoking, Eating and Alcohol, Mobile and electronic devices

We must act as if we were playing these championships "live", therefore, the following is strictly forbidden during play:

- Mobile phones and any other electronic devices, Mobile phones will be collected and there will be a regular check each session by the monitor.
- Eating (even if only biscuits)
- Drinking Alcohol
- Smoking
- Going to the WC without permission
- Talking loudly during or at the end of any board if the player is unhappy about his/her partner's bid, hand play or defense.





Roster - Senior Teams

Egypt

| |
|------------------------|
| Captain Ayman Azzam |
| Amr Farrag |
| Ayman Azzam |
| Khaled Abaza |
| Ahmed Zein |
| Mohamed El Baz |
| Ashraf Wahdan |

Kenya

| |
|---------------------------|
| Captain Bhanumati Shah |
| Bhanumati Shah |
| Saleem UD Deen |
| Samina Ismail |
| Vimla Virjee |
| Sumitra Shah |

Morocco

| |
|--------------------------------|
| Captain Abdellatif Belkouch |
| Abdellatif Belkouch |
| Pierre Sibony |
| Jean Hayet |
| Guy Cambournac |
| Hayat Hachimi |
| Med Said Berrada |

Reunion

| |
|-----------------------------|
| Captain Philippe Lagache |
| Philippe Lagache |
| Jean-Marc Breslaw |
| Geneviève Vigna |
| Catherine Aouate |
| Narguis Huseinali |
| Christian Giraud |

South Africa

| |
|-------------------------|
| Captain Brian Pincus |
| Brian Pincus |
| Larry Chemaly |
| Diniar Minwalla |
| James Grant |
| Nicky Bateman |
| Val Bloom |

47th WORLD BRIDGE TEAMS CHAMPIONSHIPS
14th WORLD TRANSNATIONAL OPEN TEAMS
 Herning, Denmark • 20 - 31 August, 2025* *Registration and Opening Ceremony on 19 August





Roster - Mixed Teams

Egypt

| |
|------------------------------|
| Captain Baher Ahmed (NPC) |
| Manal Sallam |
| Rita Ghosn |
| Farida Botrous |
| Moaz Hammam |
| Hany Dagher |
| Ahmed Nayer |

Kenya

| |
|-----------------------|
| Captain Sejal Shah |
| Sejal Shah |
| Warren Stanley |
| Kamal Shah |
| Karima Popat |
| Raksha Shah |
| Paresh Shah |

Morocco

| |
|----------------------------|
| Captain Tazi Abderrahim |
| Tazi Abderrahim |
| Rokia Hamamsi |
| Fatim Lahlou |
| Elie Levy |
| Lamia Benyahia |
| Richard Bitton |

Reunion

| |
|--------------------------|
| Captain Patrick Hamel |
| Patrick Hamel |
| Régine Wan Hoi |
| Marie-Thérèse Boyer |
| Patrick Schilli |
| Denise Bauquier |
| Jean-Luc Neulat |

South Africa

| |
|---------------------------|
| Captain Imitiaz Kaprey |
| Imitiaz Kaprey |
| Diana Rosslee |
| Gregory Hingle |
| Lorraine Weers |
| Chris Child |
| Anton Der Kinderen |

Tunisia

| |
|--------------------------------|
| Captain Mohamed Rebai (NPC) |
| Halima Mejri |
| Jalila Ghodhbane |
| Maissa Farhani |
| Mohamed Ali Lakdhar |
| Moez Fourati |
| Anis Ghodhbane |





Roster - Open Teams

Egypt

Captain

Yehia El Shazly

Walid El Ahmady

Reda Amiry

Ahmed Samir

Aly El Selehdar

Ahmed Omran

Ahmed Yousry

Kenya

Captain

Sejal Shah

Sejal Shah

Kamal Shah

Punam Shah

Bijal Shah

Bhanumati Shah

Warren Stanley

Morocco

Captain

Khalil Bensouda

Khalil Bensouda

Andre O'Hana

Said Badri

Mohammed A Ammor

Tariq Sbili

Said Sbili

Reunion

Captain

Christian Giraud

Christian Giraud

Philippe Lagache

Narguis Huseinali

Patrick Hamel

Marie-Thérèse Boyer

Patrick Schilli

South Africa

Captain

Robert Stephens

Robert Stephens

Hennie Fick

Alon Apteker

Craig Gower

Noah Apteker

Neville Eber

Tunisia

Captain

Wissem Belazreg

Wissem Belazreg

Anas Mestiri

Omar Meddeb

Ahmed Medeb

Anis Ghodhbane

Moez Fourati





Roster - Women Teams

| Egypt |
|------------------------------|
| Captain Ayman Azzam (NPC) |
| Hoda Soliman |
| Dina El Awady |
| Nadia Taymour |
| Nessreine Hamdy |
| Nada Moussa |
| Christina Miami |
| Kenya |
| Captain Samina Ismail |
| Samina Ismail |
| Sumitra Shah |
| Samira Soni |
| Rupal shah |
| Vina Verjee |
| Trupti Haria |
| Morocco |
| Captain Fatim Lahlou |
| Fatim Lahlou |
| Samira Teber |
| Graziella Nabil |
| Salwa Ayad |
| Khadija Marrakchi |
| Marie Claire O'Hana |

| South Africa |
|---------------------------|
| Captain Tas Nestoridis |
| Roz Bernstein |
| Sharon Lang |
| Vanessa Armstrong |
| Carol Stanton |
| Lotte Sorensen |
| Tas Nestoridis |
| Tunisia |
| Captain Hedia Sellami |
| Hedia Sellami |
| Ferdous Trabelsi |
| Jalila Ghodhbane |
| Maissa Farhani |
| Halima Mejri |
| Najeh Linda |





RealBridge Playing Instructions

First : Log in , Lobby, at the table and Settings

1. To join any RealBridge game you will need a **LINK**

2. All the play links will be available on ABF website

https://www.bridgewebs.com/cgi-bin/bwop/bw.cgi?club=abf&pid=display_page24

AND you might also receive it by mail.

3. Click the link and you will be redirected to the log on page of our game which looks like the next figure ...

Notice that your video should appear in the right bottom corner of the page and mic volume showing that it works.

4. If you can't see your video then you need to allow your browser to use your cam and mic, do as follows to allow it

5. From Goggle Chrome and just before the address bar, press the lock icon

6. Allow cam and allow mic.

7. Write your name in the required field and press login – nothing else is to be done- **NO ID number will be used, (leave it blank)**

8. When you logged in you will see the lobby which almost looks like the following figure (**but this figure includes extra buttons for TDs**)

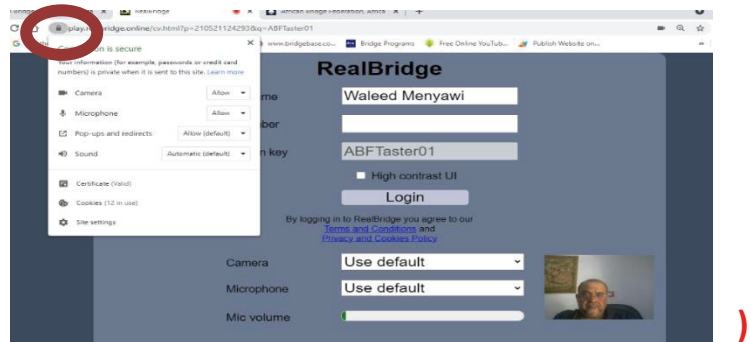

Notice the lobby chat window to the right.

**Keep an eye to the Lobby chat
- For important announcements**





13th African Bridge Championships



- 9. Each table labeled with a team name, find your table and chose where to sit (Sit N, Sit S, Sit E or Sit W)
- 10. Get familiar with the buttons at your table and call the TD using the button for help.

Volume control for your partner.

Volume control for left-hand opponent. You have a separate volume control for each player. This only affects what you hear.

Private chat with left-hand opponent. You can chat privately only with the opponents, not partner

Volume control for right-hand opponent.

Private chat with right-hand opponent.

Disable/enable your video.

Disable / enable your microphone. Use this when you're on the phone!

Hide / unhide the other players' videos. Use this if you have a poor connection.

Redial. Restarts audio and video connections. Use it if the connection fails, or if your video or audio gets out of sync.

Settings

Display style

- Detailed cards
- Simplified cards

Deal animation

Slide

Animation duration

[Slider]

As defender, see dummy

- Facing declarer
- Facing me

As declarer, see dummy as

- Vertical suits (facing declarer)
- Horizontal hand

Input style

- One click or tap
- Two taps (tablet)
- Double click (mouse)

OK Cancel

"Detailed cards" shows pictures of cards; "Simplified cards" are schematic and have larger symbols

The orientation of dummy's cards when you are defending.

The orientation of dummy's cards when you are declaring.

Choose the way you make bids and plays. With "Two taps", the first tap selects the card, then the second tap confirms. "Double click" means that you make two fast clicks.

This controls how a new hand arrives at the beginning of each deal. Choose an effect, or set to "None" to have the hand simply appear.

If you have an animation enabled, use the slider to control how long the animation lasts.





13th African Bridge Championships



11. After we play all boards

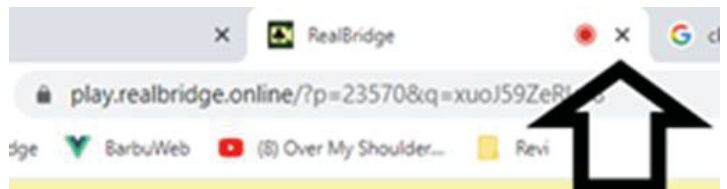

Leave RealBridge, close the tab. See the small X? just click it.



12. Can Use and Can't use

| Can Use | Can't use |
|---|---|
| <ul style="list-style-type: none"> • Windows laptop • Windows desktop • MacBook or another Apple laptop • iMac or another Apple desktop • Chromebook | <ul style="list-style-type: none"> • Smartphone • Old iPads, older than 2018. |

You must use one of these web browsers (you probably are using one of them!):

| Can Use ü | Can't use û |
|--|--|
| <p>Edge, Chrome, Firefox, Safari. The logo must look like one of these – exactly as below. If it looks different, you are using an out-of-date version. <i><u>If you are choosing amongst your browsers, we advise that you chose something other than Firefox.</u></i></p> | <p>Internet Explorer (notice the gold band) The old EDGE (see shape of the e)</p> |
|  |  |

Second : Bidding, Play, Alert and System

13. **At the start** of any session, All the team members are required to be seated at the same table (Table with the **team name label**), the system will automatically move the EW pairs to the opponents table when we start the session **and will send them back to their home table when both tables finish playing the boards.**

14. **Private chat and Table chat**

- It is strongly recommended to use the chat rather than the vocal chat; the TDs will not take into consideration any vocal explanation if you have any case.
- I will show you now, 2 figures and will appoint to you where to find the table chat (where the 4 players can see your chat) and where to find the private chat where you can chat privately with one of your opponents (not your partner of-course 😊).





13th African Bridge Championships

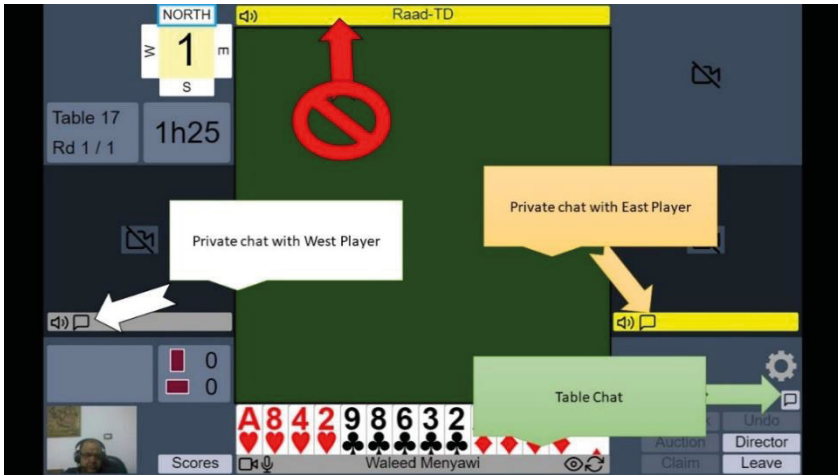

When you are at Full Screen mode

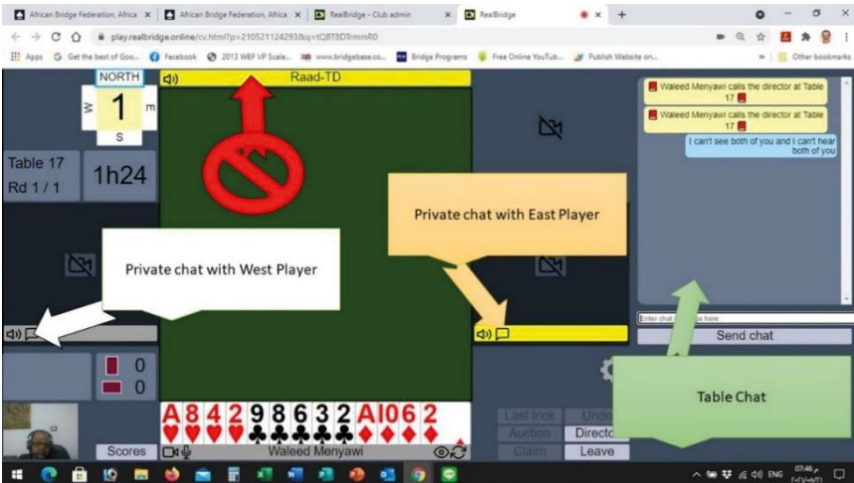

When you are at normal view (NOT Full Screen mode

15. Self-alert and self-explanation proper procedure:

1. Click alert (if required)
2. Write / Put in explanation
3. Make bid

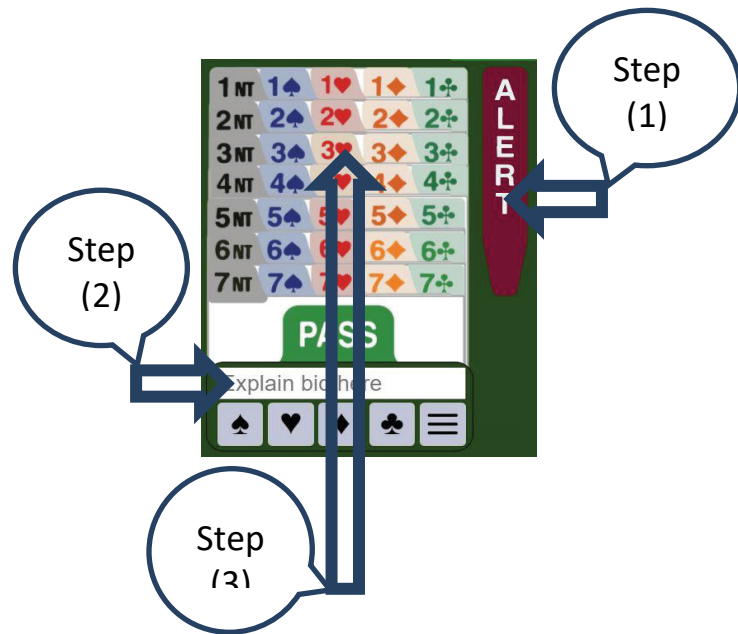



If you make a **mistake** or need to **explain your bid further** after you have bid, you can click on the bid and add more text.

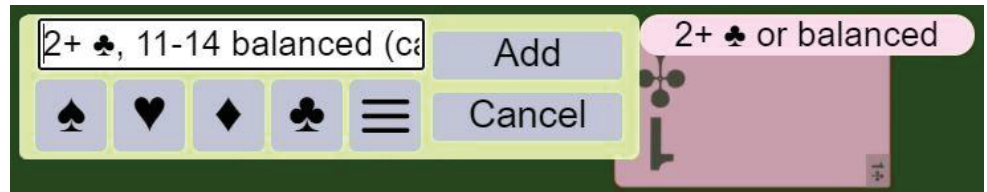

The added text will appear after an asterisk *. The time in seconds between when the bid was **made** and the added explanation was **submitted** is presented after the added text in the square brackets, for this example, 26 seconds. The character limit on explanations is 200 characters.

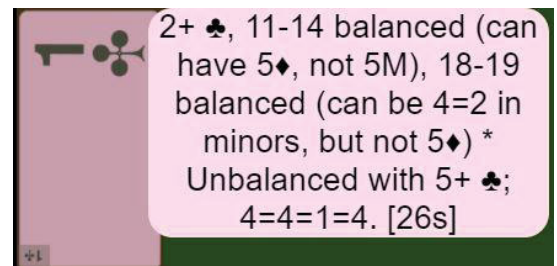

16. System

All teams are required to write a brief about their system at the table chat box before the start of first board in each match.

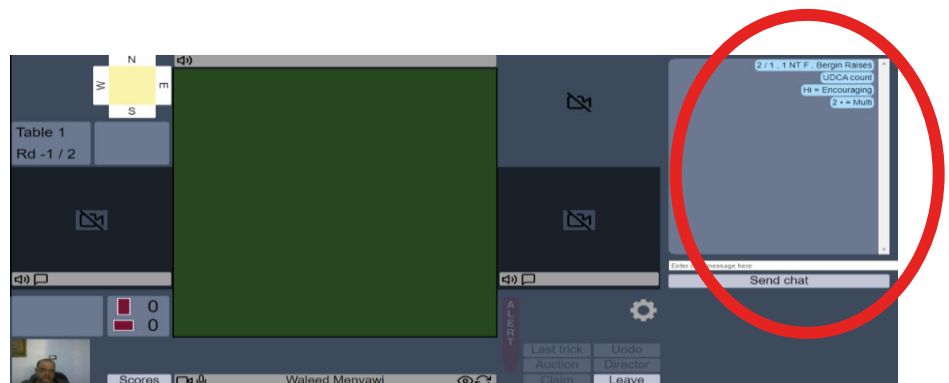



How to load your system card (convention card)

Step 1

Copy the link to your system card/convention card from where it is on the web, like this:

- Find your card.
- Click the **Copy Link** button next to the system card name.

| Team | Link to card | Added/Updated | Copy link |
|-----------|---|-------------------|-----------|
| CALEDONIA | CC Sam Patsch & Jen Middleton.pdf | 18 Apr 2025 21:24 | Copy link |
| CALEDONIA | McQuaker-McGowan WBF 2025.pdf | 8 Apr 2025 21:13 | Copy link |
| CALEDONIA | adamson mlina wbf Feb 2025.pdf | 5 Apr 2025 17:08 | Copy link |
| CASTELS | Hoja de convenciones Maria Manilla- Laura Casella 2024-2025.pdf | 10 Apr 2025 11:07 | Copy link |

Step 2

When sitting at the table, click the System Card/Convention Card icon to the right of your grey name-band at the bottom of the window.

This box appears:



Step 3

Paste your system card/convention card link into the box. To paste the link:

- On Windows, right-click in the box. Then do **Paste**.
- On a Mac, hold down **Ctrl** and click in the box. Then do **Paste**.
- On an iPad, long-press in the box. Then do **Paste**.

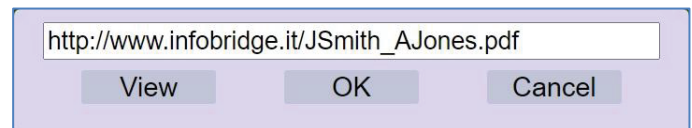
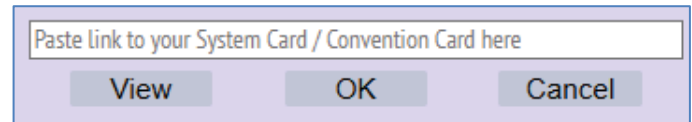

Click OK.

