

African Bridge Federation



13th ♠♥♦♣

African Bridge Championships

Online - 2025

From April 27th To May 10th



RealBridge

Bulletin 2

Tuesday 29th April

Editor Ron Tacchi

Herning Is The Goal

The first complete Round Robin has finished and so we now embark on the second of the three sets.

In the Mixed Championship **Egypt** maintains its lead of nearly a match but it has lost its unbeaten record. **Tunisia** lies second, with **Morocco** six points behind and **South Africa** take the fourth spot a further seven points adrift.

The Seniors Championship is led by **Egypt** but they too lost their unbeaten record today. **South Africa**, **Morocco** and **Reunion** are a tightly knit bunch sixteen behind.

Dear Captains

In response to the request of Reunion teams the organizing committee decided to change the starting time of the 3rd session during the Round Robin stage to be 15H30 GMT instead of 15H20 GMT, starting from today's session.

Please share with your team-mates.

Thanks

Suite à la demande des équipes réunionnaises

Le comité d'organisation a décidé de modifier l'heure de départ de la 3e session de l'étape RR à 15h30 GMT au lieu de 15h20 GMT, à compter de la session d'aujourd'hui.

N'hésitez pas à partager cette information avec vos coéquipiers.

Merci.

Standings

Mixed Team	VPs	Position
Egypt	86.56	1
Tunisia	71.60	2
Morocco	63.31	3
South Africa	56.76	4
Reunion	45.58	5
Kenya	35.79	6

Senior Team	VPs	Position
Egypt	84.66	1
South Africa	68.36	2
Morocco	65.42	3
Reunion	61.65	4
Kenya	31.91	5





Schedule for Tuesday 29th April

Note all times are GMT

Senior Championship

R.R (02)		Match (02), 09H00			Match (03), 12H30			Match (04), 15H30		
Date	Table No.	Home Team	X	Visiting Team	Home Team	X	Visiting Team	Home Team	X	Visiting Team
TUE 29	1	1 MOR	x	5 KEN	4 REU	x	1 MOR	1 MOR	x	3 RSA
	2	4 REU	x	6 --	3 RSA	x	5 KEN	2 EGY	x	4 REU
	3	3 RSA	x	2 EGY	2 EGY	x	6 --	6 --	x	5 KEN

Mixed Championship

R.R (02)		Match (02), 09H00			Match (03), 12H30			Match (04), 15H30		
Date	Table No.	Home Team	X	Visiting Team	Home Team	X	Visiting Team	Home Team	X	Visiting Team
TUE 29	4	1 EGY	x	5 REU	4 MOR	x	1 EGY	1 EGY	x	3 RSA
	5	4 MOR	x	6 KEN	3 RSA	x	5 REU	2 TUN	x	4 MOR
	6	3 RSA	x	2 TUN	2 TUN	x	6 KEN	6 KEN	x	5 REU

Results

Mixed Championship

Session 1	VPs
South Africa - Egypt	3.12-16.88
Morocco - Tunisia	5-15
Reunion - Kenya	8.24-11.76
Session 2	
Egypt- Tunisia	4.81-15.19
South Africa - Kenya	10-10
Morocco - Reunion	15.19-4.81
Session 3	
Kenya - Egypt	5.4-14.6
Reunion - Tunisia	10.91-9.09
Morocco - South Africa	9.39-10.61

Senior Championship

Session 1	VPs
South Africa - Morocco	14.18-5.82
Reunion - Egypt	5-15
Kenya - Bye	12-0
Session 2	
Morocco - Egypt	10.91-9.09
South Africa - Bye	12-0
Reunion - Kenya	13.04-6.96
Session 3	
Bye - Morocco	0-12
Kenya - Egypt	5.4-14.6
Reunion - South Africa	2.97-17.03





South Africa vs. Kenya - Seniors

On the last match of the first day South Africa took on Kenya in the Seniors Championship. Both teams had had a poor start and needed a good match to steady their nerves.

he appears to have three losers. If you examine the club suit you will see that because of the two doubleton honours in the South hand there is only one loser in the suit. 11 IMPs to South Africa.

Board 33. Dealer North. None Vul.

♠ K 10 5 3 ♥ Q 6 ♦ Q 9 5 ♣ Q 8 7 3	<div style="display: flex; justify-content: space-around; align-items: center;"> <div style="background-color: #008000; color: white; padding: 5px; border: 1px solid white;">N</div> <div style="background-color: #008000; color: white; padding: 5px; border: 1px solid white;">E</div> </div> <div style="display: flex; justify-content: space-between; align-items: center; margin-top: 5px;"> <div style="background-color: #008000; color: white; padding: 5px; border: 1px solid white;">W</div> <div style="background-color: #008000; color: white; padding: 5px; border: 1px solid white;">S</div> </div>	♠ A 8 7 2 ♥ A K J 8 5 ♦ — ♣ 9 6 5 4	♠ Q 9 4 ♥ 7 ♦ A K 10 8 7 4 3 ♣ K 10
---	---	--	--

Board 34. Dealer East. N/S Vul.

♠ 9 3 ♥ J 7 5 2 ♦ J 10 5 4 ♣ 8 6 2	<div style="display: flex; justify-content: space-around; align-items: center;"> <div style="background-color: #008000; color: white; padding: 5px; border: 1px solid white;">N</div> <div style="background-color: #008000; color: white; padding: 5px; border: 1px solid white;">E</div> </div> <div style="display: flex; justify-content: space-between; align-items: center; margin-top: 5px;"> <div style="background-color: #008000; color: white; padding: 5px; border: 1px solid white;">W</div> <div style="background-color: #008000; color: white; padding: 5px; border: 1px solid white;">S</div> </div>	♠ K 5 4 ♥ A 9 4 3 ♦ K 9 7 ♣ A 10 3	♠ Q ♥ K Q 10 6 ♦ A 8 6 2 ♣ K J 5 4
---	---	---	---

Open Room

West	North	East	South
<i>Esmail</i>	<i>Bloom</i>	<i>Bhanumati</i>	<i>Bateman</i>
–	Pass	1♥	2♦
2♥	2NT*	3♥	4♦
All Pass			

I confess with that West hand I would have bid Four Hearts at the first opportunity, getting the hand off my chest and putting the opponents to the test. The alert described 2NT as weak support so now East is in a bit of a bind as she seems to have some defensive values and might be hopeful of diamond defensive values opposite, unfortunately this was not the case. Declarer was not hard pressed when the defence started with the ♥10 which held the trick and unfortunately switched to the jack of spades which solved declarer's only problem and so ten tricks were taken.

Closed Room

West	North	East	South
<i>Chemaly</i>	<i>Virjee</i>	<i>Grant</i>	<i>Shah</i>
–	Pass	1♥	2♦
4♥	All Pass		

Just for once the bid I would have made turns out to be the correct one (well it's quite likely as I can see all four hands!). Declarer made eleven tricks though

Open Room

West	North	East	South
<i>Esmail</i>	<i>Bloom</i>	<i>Bhanumati</i>	<i>Bateman</i>
–	–	1♦	3♠
Double	Pass	4♥	All Pass

Good bidding to a good contract. South led her ace of spades and continued with the jack which declarer took with the queen. Declarer started well by cashing the king then the ace of trumps exposing the trump position. A successful finesse against the queen of clubs followed and a small heart to the ♥10 allowed trumps to be drawn. Mysteriously declarer cashed the ace of clubs and what I assume was a mislick played a club to the jack and South could now take her queen and cash two spades to defeat the contract.

Closed Room

West	North	East	South
<i>Chemaly</i>	<i>Virjee</i>	<i>Grant</i>	<i>Shah</i>
–	–	1♦	3♠
3NT	All Pass		

A bold bid by West, but a successful one. After the spade lead declarer played the hearts correctly and just took his top nine tricks, not caring about the possible two overtricks which would have been worth an extra IMP He could duck the second spade to guard against a six-card pre-empt, play





13th African Bridge Championships



the hearts correctly and take the club finesse into the safe hand for a guaranteed overtrick and it succeeded perhaps two additional tricks. 10 IMPs to South Africa.

Board 35. Dealer South. E/W Vul.

♠ Q6
 ♥ 6
 ♦ QJ109873
 ♣ J107

♠ 975
 ♥ Q7543
 ♦ K64
 ♣ K3

♠ K1082
 ♥ K102
 ♦ 5
 ♣ Q8652

Open Room

West	North	East	South
<i>Esmail</i>	<i>Bloom</i>	<i>Bhanumati</i>	<i>Bateman</i>
-	-	-	Pass
1♣	3♦	Pass	Pass
Double	Pass	3♥	All Pass

Can East find a Four Hearts bid over partner's Double? If you believe that the Double shows a good hand and some hearts then he answer is yes, if you think partner could make this bid on a much weaker hand the answer is no, but you are at the absolute maximum for such a decision – vulnerable games win matches. Declarer handled the trump suit correctly by starting with the ♥Q to guard against ♥K10x in the South hand.

Closed Room

West	North	East	South
<i>Chemaly</i>	<i>Virjee</i>	<i>Grant</i>	<i>Shah</i>
-	-	-	Pass
1♣	2♦	Pass	Pass
Double	Pass	3♥	Pass
4♥	All Pass		

When North only made a weak jump overall East could now express his values with a jump to Three Hearts and West had an obvious raise to game. On the lead of South's singleton diamond declarer won and attacked trumps by playing ace and another, happy to lose a trump trick but guarding against a possible diamond ruff. All passed off peaceably and declarer lost a trump and two spades for his contract. 9 more IMPs to South Africa who had amassed 30 IMPs on the first three boards.

Board 40. Dealer West. None Vul.

♠ AJ1074
 ♥ 87
 ♦ 982
 ♣ 532

♠ Q8532
 ♥ J
 ♦ AKJ4
 ♣ KQ8

♠ 6
 ♥ A42
 ♦ Q10653
 ♣ AJ96

♠ K9
 ♥ KQ109653
 ♦ 7
 ♣ 1074.

Open Room

West	North	East	South
<i>Esmail</i>	<i>Bloom</i>	<i>Bhanumati</i>	<i>Bateman</i>
1♠	Pass	1NT	3♥
Pass	Pass	Double	All Pass

East's 1NT is almost certainly forcing for one round but the Kenyans seem to have changed partnerships and I cannot find one for this pairing. South's pre-empt definitely interfered with their opposition's bidding. While East's Double partially mitigated the result it did not find the best spot. The 1NT bid if is played in other Kentan convention cards states it is from 0-11, this effectively rules out many actions from partner when there is interference. The defence took all the available tricks and so declarer was two light.

Closed Room

West	North	East	South
<i>Chemaly</i>	<i>Virjee</i>	<i>Grant</i>	<i>Shah</i>
1♠	Pass	1NT	2♥
3♦	Pass	3♥	Pass
4♦	Pass	6♦	All Pass

According to the convention card the 1NT bid was semi-forcing but there appears to have been no alert. West was not inconvenienced by the heart overcall and showed a strong hand with diamonds and now East with his absolute maximum went for the slam. After the heart lead declarer exercised caution when ruffing two hearts in dummy and brought an easy twelve ticks and the same number of IMPs.





13th African Bridge Championships



Board 45. Dealer North. All Vul.

♠ AQ98	<table border="1"> <tr><td>N</td></tr> <tr><td>W E</td></tr> <tr><td>S</td></tr> </table>	N	W E	S	♠ J73
N					
W E					
S					
♥ 97532	♥ K1084				
♦ J2	♦ 974				
♣ A9	♣ Q86				
♠ K1054					
♥ A6					
♦ K103					
♣ J1052					

Open Room

West	North	East	South
<i>Esmail</i>	<i>Bloom</i>	<i>Bhanumati</i>	<i>Bateman</i>
-	1♦	Pass	1♠
2♥	Pass	Pass	Double
Pass	3♣	All Pass	

I can see no reason for continuing after the Three Clubs bid. It is just about the par contract. After the opening heart ran round successfully to declarer's queen she cashed the ace and played a small trump to her king – with East having shown up with the ♥K and not found a bid it was unlikely that the trump ace was with East. Now when a small trump was led from hand East gave declarer an overtrick by rising with the ♣Q.

Closed Room

West	North	East	South
<i>Chemaly</i>	<i>Virjee</i>	<i>Grant</i>	<i>Shah</i>
-	1♦	Pass	1♠
Pass	2♣	Pass	3NT
All Pass			

South, perhaps valuing his plethora of tens went for the vulnerable game. West led the ♥3 to the queen, king and ace and now declarer ran the jack of clubs round to East's queen. The ♥4 came back taken in dummy. Declarer now ran five rounds of diamonds on which West discarded all his hearts so now when a small club was won by West he had to give a spade trick to declarer for an overtrick in a contract that was destined to fail. So that was 11 IMPs to Kenya.

Board 46. Dealer East. None Vul.

♠ KJ109	<table border="1"> <tr><td>N</td></tr> <tr><td>W E</td></tr> <tr><td>S</td></tr> </table>	N	W E	S	♠ A762
N					
W E					
S					
♥ K75	♥ 10632				
♦ QJ73	♦ 864				
♣ J2	♣ K5				
♠ Q3					
♥ A84					
♦ AK2					
♣ AQ1084					
♠ 854					
♥ QJ9					
♦ 1095					
♣ 9763					

Open Room

West	North	East	South
<i>Esmail</i>	<i>Bloom</i>	<i>Bhanumati</i>	<i>Bateman</i>
-	-	Pass	Pass
1♣	Pass	1♥	Pass
2NT	Pass	3NT	Pass
4♥	All Pass		

I do not see the reasoning behind the Four Hearts bid, I am sure East has some way of showing more than four cards in hearts and so the 3NT response describes the hand shown perfectly. South commenced hostilities with the ♦10, taken in dummy. A heart was ducked to South and she made the only return to beat the contract, viz. a spade, now declarer was without resource and had to lose four tricks and so 10 IMPs to South Africa.

Closed Room

West	North	East	South
<i>Chemaly</i>	<i>Virjee</i>	<i>Grant</i>	<i>Shah</i>
-	-	Pass	Pass
1♣	Dble	1♠	Pass
3NT	All Pass		

A diamond was led and taken in hand. When declarer cashed two top clubs he noted the fall of the jack and took his nine top tricks and 10 IMPs to South Africa.

At the close of play South Africa had played a much tighter game and finished winners 54-19 or 17.45-2.55 VPs.





Reunion vs. Kenya - Mixed

At the start of the second day in the Mixed Championship Reunion were taking on Kenya. Kenya had yet to score a win and Reunion had not had the results for which they had been hoping.

Board 2. Dealer East. N/S Vul.

♠ K9 ♥ 9 ♦ J1096 ♣ KQ9642	<table style="margin: auto; border: 1px solid #008000; background-color: #008000; color: white; padding: 5px;"> <tr><td style="padding: 2px;">N</td><td style="padding: 2px;">E</td></tr> <tr><td style="padding: 2px;">W</td><td style="padding: 2px;">S</td></tr> </table>	N	E	W	S	♠ 732 ♥ K10843 ♦ K32 ♣ 53	♠ Q8654 ♥ AQ62 ♦ A54 ♣ 7
N	E						
W	S						

Open Room

West	North	East	South
<i>Sejal</i>	<i>Hamel</i>	<i>Stanley</i>	<i>Wan Hoi</i>
-	-	Pass	1♠
Pass	1NT*	Pass	2♥
Pass	2NT	All Pass	
1NT	forcing		

With her bare minimum South could not advance to game. The heart lead was won by West's jack and she returned the ♣8 which declarer won with the queen. Declarer now made the slightly strange decision to play the king of clubs which West gratefully took, noticing he had two more tricks in the suit. A switch to a diamond saw East's king headed by dummy's ace and another diamond played. West took her queen and cashed out for one off.

Closed Room

West	North	East	South
<i>Neulat</i>	<i>Popat</i>	<i>Bauguier</i>	<i>Shah</i>
-	-	Pass	1♠
Pass	1NT	Pass	2♥
Pass	3NT	All Pass	

I am not sure South had promised any more than an opening bid but North had not come here to play in a part-score and so went for the vulnerable game. The defence did not get off to the best start

when East eschewed a heart lead and tried a diamond instead which West won with the queen and returned the suit. Declarer's ♦9 was headed by the king and ace. A small club went to declarer's king and the king of spades was led. West took this and continued the now futile diamond attack. Declarer took that trick and played the thirteenth diamond, West discarding a club, before taking a successful heart finesse. Now a spade set up enough tricks for declarer, if West took the trick and played on clubs declarer's hand would be high and any other play gave an entry to dummy to cash enough winners. Well played by declarer, 13 IMPs to Kenya.

Board 3. Dealer South. E/W Vul.

♠ 102 ♥ 9842 ♦ 542 ♣ 10954	<table style="margin: auto; border: 1px solid #008000; background-color: #008000; color: white; padding: 5px;"> <tr><td style="padding: 2px;">N</td><td style="padding: 2px;">E</td></tr> <tr><td style="padding: 2px;">W</td><td style="padding: 2px;">S</td></tr> </table>	N	E	W	S	♠ A94 ♥ AKQ63 ♦ K93 ♣ AQ	♠ QJ ♥ 1075 ♦ AJ106 ♣ KJ72
N	E						
W	S						

♠ K87653 ♥ J ♦ Q87 ♣ 863

Open Room

West	North	East	South
<i>Sejal</i>	<i>Hamel</i>	<i>Stanley</i>	<i>Wan Hoi</i>
-	-	-	Pass
1♦	Pass	1♥	Pass
1NT	Pass	6NT	All Pass

When South did not advertise her spade suit some rustic but effective bidding got the slam bid. North had to divine what was the best lead from his near Yarborough hand. He chose a club and now declarer, with twelve tricks on top took the opportunity of taking the successful diamond finesse for the thirteenth trick.

Closed Room

West	North	East	South
<i>Neulat</i>	<i>Popat</i>	<i>Bauguier</i>	<i>Shah</i>
-	-	-	2♦
Pass	2♥	Double	2♠
3♠	Pass	3NT	All Pass





13th African Bridge Championships



Yet again we see that the Multi caused the opposition problems and they failed to reach the slam. On a diamond lead declarer quickly claimed thirteen tricks but it was 13 IMPs to Kenya

Board 4. Dealer West. All Vul.

♠ AJ1042
 ♥ AK9
 ♦ KJ1052
 ♣ —

♠ Q765
 ♥ Q532
 ♦ 43
 ♣ 972

♠ K8
 ♥ J74
 ♦ A976
 ♣ Q1086

♠ 93
 ♥ 1086
 ♦ Q8
 ♣ AKJ543

Open Room

West	North	East	South
<i>Sejal</i>	<i>Hamel</i>	<i>Stanley</i>	<i>Wan Hoi</i>
Pass	1♠	Pass	1NT
Pass	3♦*	Pass	3NT
All Pass			
3♦	5-5		

The ♥2 lead was taken in dummy with the ace and declarer played a small diamond to her queen which held the trick, the ♠9 ran to East's king but decided against following up on partner's initial lead switched to a club, declarer gratefully took the ace and with multiple ways of now making her contract took a winning spade finesse before attacking diamonds

Closed Room

West	North	East	South
<i>Neulat</i>	<i>Popat</i>	<i>Bauguier</i>	<i>Shah</i>
Pass	1♠	Pass	1NT
Pass	3♦	Pass	4♠
All Pass			

Rightly or wrongly South decided partner should play this game and on the lead of a heart declarer won. It is obvious that declarer needs to get to dummy to cash a club to dispose of a losing heart. Declarer failed in this endeavour by trying the ♦10 from hand, this was never going to collect the ace and now there was no easy entry to dummy. On the next round of diamonds East took the ace and continued the suit. Dummy ruffed with the ♠9 but now West's small pips in the trump suit became all powerful and the defence had three trump tricks to come. One off and 12 IMPs to Reunion.

Board 10. Dealer East. All Vul.

♠ Q107
 ♥ QJ102
 ♦ AKJ2
 ♣ 109

♠ J98432
 ♥ 3
 ♦ 97
 ♣ AQ52

♠ A5
 ♥ AK9754
 ♦ 10654
 ♣ 4

♠ K6
 ♥ 86
 ♦ Q83
 ♣ KJ8763

Open Room

West	North	East	South
<i>Sejal</i>	<i>Hamel</i>	<i>Stanley</i>	<i>Wan Hoi</i>
–	–	2♥*	Pass
Pass	2NT	Pass	3NT
All Pass			
2♥	Weak		

When 2♥ was alerted as weak I nearly fell off my chair. I have a feeling one of those aces was hidden behind another card. The ♥K lead was followed by the ace and another. Winning in hand declarer took an unsuccessful club finesse and West returned a diamond won by declarer who knocked out the ♣A but West led a spade and was probably surprised when East produced the ace to take the contract down.

Closed Room

West	North	East	South
<i>Neulat</i>	<i>Popat</i>	<i>Bauguier</i>	<i>Shah</i>
–	–	1♥	Pass
1♠	1NT	2♥	3NT
All Pass			

A bold intervention by a vulnerable North, he could easily have come unstuck as neither East nor West were at this point limited. Partner obviously believed there was a genuine 1NT overcall and promptly raised to game. A surprising fourth best lead of the ♥7 saw dummy's ♥8 take the trick. A small club from dummy was won with declarer's ♣9 and then West took the club continuation with the queen. Now West needed to cash his ace of clubs otherwise it would never be played but he exited with a spade and now with two spade tricks set up declarer could force another heart trick and those with the four diamonds came to nine tricks and a game swing. 12 IMPs to Kenya.

After a ding-dong battle Kenya emerged the winners by the small margin of 49-43 or 11.76-8.24 VPs.





Reunion vs. Egypt - Seniors

In the Seniors championship the fourth session of the first Round Robin pitted Reunion against Egypt who as yet had to be beaten and Reunion were lying second in the table, so lots to play for.

Board 1. Dealer North. None Vul.

♠ A1085	<table border="1"> <tr><td>N</td></tr> <tr><td>W E</td></tr> <tr><td>S</td></tr> </table>	N	W E	S	♠ J3
N					
W E					
S					
♥ AK92	♥ 1075				
♦ 10732	♦ AKJ4				
♣ A	♣ J873				
	♠ K42				
	♥ J43				
	♦ Q				
	♣ Q109654				

Open Room

West	North	East	South
Abaza	Vigna	Zein	Lagache
-	Pass	Pass	Pass
1♦	Pass	1NT	Pass
2NT	Pass	3NT	Pass
All Pass			

West with his absolute maximum (15 points and two tens) invited game, accepted by East. On the lead of the ♣10 North unblocked his king under dummy's ace. A diamond to the ace guaranteed four tricks in the suit when the queen fell. Now declarer turned his attention to the heart suit and played three rounds getting the good news of the kind split. North winning with the queen played back a club ducked to South's ♣9 and he switched to a spade which went to North's queen. The exit was diamond taken in dummy and the thirteenth heart cashed before declarer cashed the last two diamonds in hand squeezing South in the process, he could not keep two spades and the master club in the two card ending, always petty to have a little squeeze on board one.

Closed Room

West	North	East	South
Giraud	Nazzam	Huseinali	Farrag
-	Pass	Pass	Pass
1♦	Pass	1NT	All Pass

I am surprised that West did not make an effort. The upshot was that game was missed and that was 7 IMPs to Egypt

Board 3. Dealer South. E/W Vul.

♠ 102	<table border="1"> <tr><td>N</td></tr> <tr><td>W E</td></tr> <tr><td>S</td></tr> </table>	N	W E	S	♠ A94
N					
W E					
S					
♥ 9842	♥ AKQ63				
♦ 542	♦ K93				
♣ 10954	♣ AQ				
♠ QJ		♠ K87653			
♥ 1075		♥ J			
♦ AJ106		♦ Q87			
♣ KJ72		♣ 863			

Open Room

West	North	East	South
Abaza	Vigna	Zein	Lagache
-	-	-	2♦*
Pass	2♥	Double	2♠
3♦	Pass	3♠	Pass
4♣	Pass	4NT	Pass
5♦	Pass	6♦	All Pass

Declarer obviously played North for the queen of trumps and so after the spade lead was a quick one down. The problem was in the auction: the contract would have been made played from the East hand as would 6♥ and 6NT. I cannot be sure of the methods employed against the Multi by this team but a standard defence against the opening three bids is that the Double is for takeout of hearts and a very strong hand with stops in both majors should bid 3NT. I suspect there are some pairs who have not fully discussed this situation with such a hand as East's on this occasion.





13th African Bridge Championships



Closed Room

West	North	East	South
Giraud	Nazzam	Huseinali	Farrag
-	-	-	2♦
Pass	2♠*	Double	Pass
2NT	Pass	4♥	All Pass

Again a question about how to deal with the Multi Two Diamonds. I do not have enough pages to deal with all the possible defences to it. I can only recommend reading 'The Mysterious Multi' from Master Point Press by Mark Horton. Reunion were fortunate to gain 13 IMPs in missing a cold slam.

Board 6. Dealer East. E/W Vul.

♠ 543		♠ AK87			
♥ J		♥ A			
♦ K1086		♦ Q9543			
♣ A7642		♣ Q83			
♠ Q962	<table border="1"> <tr><td>N</td></tr> <tr><td>W E</td></tr> <tr><td>S</td></tr> </table>	N	W E	S	♠ J10
N					
W E					
S					
♥ K10932	♥ Q87654				
♦ 7	♦ AJ2				
♣ J109		♣ K5			

Open Room

West	North	East	South
Abaza	Vigna	Zein	Lagache
-	-	1♦	1♥
Pass	Pass	Double	2♥
2♠	All Pass		

In a valiant effort to beat the unbeatable part-score the defence allowed a second overtrick.

Closed Room

West	North	East	South
Giraud	Nazzam	Huseinali	Farrag
-	-	1♦	1♥
1♠	Pass	4♠	All Pass

Did East expect more in terms of high cards and/or spades from the free bid by West, apparently so. Declarer took the opening heart lead in dummy, perforce with the ace and perhaps with the idea of crossruffing led a small diamond off dummy, taken by North, who exited with a trump taken in dummy. A diamond was ruffed in hand and declarer tried to cash the king of hearts but this was ruffed by North and overruffed in dummy. This had the effect of declarer now only taking eight tricks instead of

nine so the contract failed by two tricks. 9 IMPs to Egypt.

Board 11. Dealer South. None Vul.

♠ AQ102		♠ 754			
♥ AKQ432		♥ 1098			
♦ -		♦ K9643			
♣ A74		♣ 85			
♠ KJ96	<table border="1"> <tr><td>N</td></tr> <tr><td>W E</td></tr> <tr><td>S</td></tr> </table>	N	W E	S	♠ 83
N					
W E					
S					
♥ J	♥ 765				
♦ Q75	♦ AJ1082				
♣ KJ1096		♣ Q32			

Open Room

West	North	East	South
Abaza	Vigna	Zein	Lagache
-	-	-	Pass
Pass	2♣	Pass	2♦
Pass	2♥	Pass	4♥

All Pass

A strong Two Clubs opening bid brought about the right contract. My finessing friend tells me the contract should make but let us watch. East found the best lead of the ♣8, declarer tried the queen but to no one's surprise this was covered by the king and ace. Declarer now tried ace and another spade, with the idea of ruffing some spades in dummy. West took this trick and cashed two clubs and another round promoted a trump in East's hand. One off.

Closed Room

West	North	East	South
Giraud	Nazzam	Huseinali	Farrag
-	-	-	Pass
1♣	Double	Pass	1♦
Pass	1♥	Pass	1NT
Pass	4♥	All Pass	

The same contract, albeit a very different route. This time when East led a club, declarer played low from dummy and placed the ♠Q on the green baize taken by West's king. With nothing else inviting West exited with his trump and now declarer could ruff a spade in dummy for his tenth trick. Once declarer had played low on the opening lead there was no defence to the contract. 10 IMPs to Egypt.

A couple of part-score swings to Reunion saw the final score of 43-23 to Egypt or 15-5 VPs, Egypt Seniors continue their unbeaten run.





Egypt vs. Tunisia - Mixed

Egypt take on Tunisia in a top of the table clash in the last session of the first Round Robin. Egypt so far are undefeated, a status they will hope to maintain whereas Tunisia will wanting to close the gap and also make sure they are well ahead of their other rivals.

Board 19. Dealer South. E/W Vul.

♠ A1086 ♥ 32 ♦ AQ98 ♣ AK6	<div style="background-color: #008000; color: white; padding: 5px; display: inline-block;"> N W E S </div>	♠ Q9 ♥ KQ10976 ♦ 105 ♣ QJ2	♠ J7532 ♥ A4 ♦ K763 ♣ 53
♠ K4 ♥ J85 ♦ J42 ♣ 109874.			

Open Room

West	North	East	South
<i>Lakhdhar</i>	<i>Ghosn</i>	<i>Halima</i>	<i>Dagher</i>
–	–	–	Pass
1NT	2♥	3♥	Pass
3♠	Pass	3NT	Pass
4♠	All Pass		

Presumably Three Hearts was a transfer and West evidently preferred the major-suit game to 3NT. There was little to the play, there was a heart loser and it was almost impossible for declarer to find a way to lose two trumps tricks so the contract was made with an overtrick.

Closed Room

West	North	East	South
<i>Hammam</i>	<i>Ghodhbane</i>	<i>Sallam</i>	<i>Fourati</i>
–	–	–	Pass
1NT	2♦*	2♥	Pass
2♠	Pass	2NT	Pass
3NT	All Pass		
2♦	hearts		
2♥	transfer		

I fear I do not comprehend West's wish to play in 3NT rather than his 5-4 major-suit fit. So on the

king of hearts lead when declarer tried to establish the spade suit South still had a heart with which to give partner the lead to cash out for two off. 13 IMPs to Tunisia.

Board 21. Dealer North. N/S Vul.

♠ K6 ♥ Q103 ♦ J973 ♣ K832	<div style="background-color: #008000; color: white; padding: 5px; display: inline-block;"> N W E S </div>	♠ Q ♥ 975 ♦ 1085 ♣ J107654
♠ J109754 ♥ AKJ82 ♦ K ♣ Q	♠ A832 ♥ 64 ♦ AQ642 ♣ A9.	

Open Room

West	North	East	South
<i>Lakhdhar</i>	<i>Ghosn</i>	<i>Halima</i>	<i>Dagher</i>
–	Pass	Pass	1♦
2♦*	3♦	Pass	3♠
4♦*	Double	4♥	Pass
Pass	Double	All Pass	
2♦	Majors		
4♦	Partner—just in case you have forgotten I've got the majors		

South led the ace of diamonds and switched to a trump in the hope of cutting down on dummy's ruffs. This led to a two trick defeat but had South persisted with a forcing game an extra undertrick could have been taken.

Closed Room

West	North	East	South
<i>Hammam</i>	<i>Ghodhbane</i>	<i>Sallam</i>	<i>Fourati</i>
–	Pass	Pass	1NT
2♦*	3NT	All Pass	
2♦	both majors		

West started with ace and another heart the second being won in dummy and not having the gift of second sight took a losing diamond finesse and was promptly one down when West cashed his heart tricks. 9 IMPs to Egypt.





13th African Bridge Championships



Board 23. Dealer South. All Vul.

♠ A82		♠ Q76			
♥ A105		♥ 9842			
♦ Q106		♦ 85432			
♣ A864		♣ 3			
♠ 10954	<table border="1"> <tr><td>N</td></tr> <tr><td>W E</td></tr> <tr><td>S</td></tr> </table>	N	W E	S	♠ KJ3
N					
W E					
S					
♥ KJ3		♥ Q76			
♦ 97	♦ AKJ				
♣ J1052	♣ KQ97.				

Open Room

West	North	East	South
Lakhdhar	Ghosn	Halima	Dagher
-	-	-	2NT
Pass	3♣	Pass	3NT
Pass	6NT	All Pass	

More than enough points but with the duplication of the 4333 shape the contract was certainly not lay down. The opening lead of the ♠9 was taken in hand with the jack and when the clubs failed to deliver four tricks declarer had no chance and drifted one off.

Closed Room

West	North	East	South
Hammam	Ghodhbane	Sallam	Fourati
-	-	-	1NT
Pass	3NT	All Pass	

Did South run out of fingers when counting the points? I shall never know. But what it meant was that declarer was not in a doomed slam and so Tunisia gained 13 IMPs

Board 26. Dealer East. All Vul.

♠ 763		♠ AKJ84			
♥ K106		♥ AJ752			
♦ K9732		♦ 105			
♣ 108		♣ 5			
♠ 10952	<table border="1"> <tr><td>N</td></tr> <tr><td>W E</td></tr> <tr><td>S</td></tr> </table>	N	W E	S	♠ Q
N					
W E					
S					
♥ 98		♥ Q43			
♦ AQ84	♦ J6				
♣ 963	♣ AKQJ742				

Open Room

West	North	East	South
Lakhdhar	Ghosn	Halima	Dagher
-	-	1♠	3♠*
Pass	4♣	4♠	Pass
4♠	All Pass		
3♠	I have a solid running suit do you have a spade stop partner?		

East's aggression in the bidding got them to a low point game contract. The ace and king of hearts were led, declarer ruffing the second round. The ♠Q fell under the ♠A and declarer then ducked a heart to North who exited with a trump. The ace of hearts was cashed and a heart ruffed, trumps drawn and the attempt of an overtrick by taking the diamond finesse came to naught.

Closed Room

West	North	East	South
Hammam	Ghodhbane	Sallam	Fourati
-	-	1♠	2♣
2♠	Pass	3♠	All Pass

There was no reason for West to carry on with the minimum held and so the contract was a part-score. We will gloss over the play as declarer found a line of play which allowed the contract to fail. 12 more IMPs to Tunisia.

Board 28. Dealer West. N/S Vul.

♠ Q87642		♠ A			
♥ 6		♥ AK72			
♦ J75		♦ K106			
♣ A75		♣ J6432			
♠ 1095	<table border="1"> <tr><td>N</td></tr> <tr><td>W E</td></tr> <tr><td>S</td></tr> </table>	N	W E	S	♠ KJ3
N					
W E					
S					
♥ QJ8		♥ 109543			
♦ 432	♦ AQ98				
♣ Q1098	♣ K				

Open Room

West	North	East	South
Lakhdhar	Ghosn	Halima	Dagher
Pass	Pass	1♣	1♥
Pass	1♠	Pass	2♦
All Pass			

I suspect even if North had found another bid of Two Spades, game would not have been reached. When West elected to open up with a trump declarer was not hard pressed to make ten tricks.





13th African Bridge Championships



Closed Room

West	North	East	South
<i>Hammam</i>	<i>Ghodhbane</i>	<i>Sallam</i>	<i>Fourati</i>
Pass	2♦*	Pass	2NT
Pass	3♦*	Pass	4♠
All Pass			

2♦ weak multi or strong bal
3♦ spades

East took the opening trump lead and cashed a top heart before playing a diamond which declare won in hand with the ♦9. The king of clubs was unblocked, the king of trumps cashed and a heart ruffed in dummy. A club ruff in hand and another heart ruffed in dummy before drawing the last trump and a successful diamond finesse for an overtrick. 11 IMPs to Egypt.

Board 31. Dealer South. N/S Vul.

♠ J 107 ♥ AKQ6542 ♦ QJ ♣ 3	<table border="1" style="margin: auto;"> <tr><td style="padding: 5px;">N</td></tr> <tr><td style="padding: 5px;">W E</td></tr> <tr><td style="padding: 5px;">S</td></tr> </table>	N	W E	S	♠ K ♥ J97 ♦ A87632 ♣ J109
N					
W E					
S					
♠ Q942 ♥ 8 ♦ 10954 ♣ AK75	♠ A8653 ♥ 103 ♦ K ♣ Q8642.				

Open Room

West	North	East	South
<i>Lakhdhar</i>	<i>Ghosn</i>	<i>Halima</i>	<i>Dagher</i>
-	-	-	Pass
Pass	1♥	Pass	1♠
Pass	3♥	Pass	4♥
All Pass			

A club was led and continued, declarer ruffing the second round. Trumps were drawn in three rounds and the ♠10 covered by the king and ace all declarer needed to do now was to play a small spade towards hand but unfortunately tried the king of diamonds, East took the ace and played another club but now declarer had to play spades from hand and so lost two more tricks to finish one light.

Closed Room

West	North	East	South
<i>Hammam</i>	<i>Ghodhbane</i>	<i>Sallam</i>	<i>Fourati</i>
-	-	-	Pass
Pass	1♥	Pass	1♠
Pass	4♥	All Pass	

I thought it quite touching that apparently One Spade was alerted as showing spades. The same lead of a club but West took it and switched to a trump, declarer played a diamond and East hopped up with the ace and played yet another trump. Declarer now ran all of his trumps bar one and West discarded merrily his spades so when declarer played the ace of spades he saw both the king and queen appear and so made an unlikely overtrick. 13 IMPs to Egypt.

At the end of the match Egypt had proved they were fallible having lost 62-41 or 15.19-4.81 VPs. At one point they were fifty points adrift but they clawed back 29 points over the last five boards.

Dear Captains

Please pay full attention

As I received several complains about failure to alert a conventional bid by players and these complains were supported by photos against many teams.

Kindly be advised that all the conventional/artificial bids have to be alerted with fully disclosed- even if from the player's point of view it is clear

Double / Redouble / 4 NT / responses to 4NT / Transfers / Stayman / Puppet etc. as long as these bids are artificial or conventional, they must be alerted.

It has been decided that failure to do this, may result in your team receiving a penalty of 0.25 VP even if no clear damage was done.

Please, Please – Share with your team as soon as you read this





Championship Information

Your Chief Tournament Director Waleed El Menyawi explains the important procedures to be observed during the Championships:

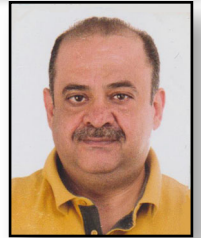

The Followings are some important information from your Head TD which need to be carefully read by each member, captain or coach of any team, please refer to the [Conditions of Contest](#) for full details.

1. Play Format: Open, Women, Seniors & Mixed teams

1. Three Complete RR (15 Matches X 16 Boards each; in 5 days)
2. The top four teams will qualify to the Semi-final stage, the first ranked team will choose its opponents from between teams ranked 3rd or 4th.
3. Semi-Final will be five Segments of 16 Boards each, No Carry Over (Check the [CoC](#) for tie-breaks).
4. For the Semi-final, Final and play-off sessions, It has been decided that:
5. - The team ranked higher after the RR stage will be the Home team in segments 3 & 5 in the Semi-final.
6. - The team ranked lower after the RR stage will be the Home team in segments 2 & 4 in the Semi-Final.
7. - The 1st Segment will be blind line up.
8. - The team ranked higher after the RR stage will be the Home team in segment 3 in the Final or Play-off.
9. - The team ranked lower will be the Home team in Segment 2 while segment 1 will be blind.
10. The Final will be three Segments of 14 Boards each, No Carry Over (Check the [CoC](#) for tie-breaks).
11. The first 2 RR will be home and away line-ups.
12. The last Round Robin shall be done according to the final ranking of the teams in the previous played 2 rounds and will be a blind line-up.

2. Teams Events ... Last RR

The last Round Robin for all categories shall be done according to the final ranking of the teams in the previous played rounds.

3. Please click the link below for instructions

[Alert Procedures - Undo Procedures - General Instructions](#)

Note that : « Systems Policy Change: Please note that as of January 1st 2025 the use of a written defence against the Multi 2 Diamonds (or 2 Clubs) is no longer permitted in WBF events

5. Play instructions and Schedule of play ...

- A. When you log on to the RealBridge game (using the game link), you will find your team





name written in one of the Tables.

B. All team members are required to sit at their table (all together) in Pairs NS and EW, later on, when we start the session, the software will automatically move the EW pairs between the tables according to the schedule of play.

C. In the schedule of play you will find Home team (the team mentioned first) and Visiting team (the team mentioned second)

D. The visiting team has to sit first at their table (Pairs NS and EW) and the Home team has the right to have a look at the visiting team and sit its pairs accordingly.

6. Request a review

1. First step is to review the TD ruling with the Head TD

2. Second step is apply for an official review by submitting a review form through the TD in charge of your case.

3. A request for a review of a Tournament Director's ruling must be lodged within 30 minutes of the first posting of the official score for the Session in which the board was played that is the subject of the ruling. All such requests must be lodged by the team's Captain or his designee, or by one member of the pair in the Pairs events.

4. When lodging a Request for Review the appellant must make a monetary deposit with the ABF monitor. The amount of deposit required will be US \$ 100 (or the equivalent in Euro)

5. The case will be reviewed by a person who was not involved in the original decision. The Reviewer will check that the TD has gathered the necessary evidence of what occurred when the infraction arose. The Reviewer will then need to be satisfied that the correct law was applied and that other TDs were consulted where appropriate. In matters involving the judgement that was exercised by a player following unauthorized information, incorrect explanation or failure to alert, the Reviewer will clarify that suitable players have been asked appropriate questions to enable a judgmental view to be obtained. Finally, the Reviewer will check that the ruling that was issued based upon all the information available to the TDs was within the bounds of reasonableness. The fact that the Reviewer might have determined a slightly different ruling would not be good reason for the ruling to be varied. In the event that the process had not been followed properly in some material way, the Reviewer will ask the Head TD to correct the failings and issue a new ruling.

7. Time delay and hesitation

- It is very important to know that the TDs have the tools to produce a board report which includes the time for each bid / play by each player, so please be bare that in mind when calling the TD for a possible hesitation or before denying it.

- It is also very important to know that the TDs also have the tools to produce a session time report which includes the exact time taken by each player in a session, in case of time delay, the penalty will be given according to this report.

8. Home & Visiting teams

- When you log in to the RealBridge game (using the game link), you will find your team name written on one of the Tables.
- All team members are required to sit at their table (all together) in Pairs NS and EW, later on, when we start the session, the software will automatically move the EW pairs between the tables according to the schedule of play.





13th African Bridge Championships



- In the schedule of play you will find Home team (the team mentioned first) and Visiting team (the team mentioned second)
- NO LINE-UP will be needed from the teams, the visiting team has to sit first at their table (in Pairs NS and EW), minimum 10 min before the official start time, and the Home team has the right to have a look at the visiting team and sit its pairs accordingly.

9. Headphones / Earphones

In order to minimize the noise in the venue as much as possible...

- It is mandatory for each player to have his own headphone / earphone which is connected to his device during play
- Use the table chat / private chat as much as possible and don't use vocal chat.
- Any vocal explanation will not be taken into the TD consideration in any case.
- You need to be very careful when using the table chat as you might give an unauthorized information to your partner which could results in adjusted score by the TD.

10. Kibitzers

- Kibitzers are not allowed by any means at 1) the playing venue, 2) RealBridge online playing room.
- All players are required to immediately leave the playing area when they finish their session, players are also kindly asked to keep their seats and not roam around the playing area.
- All the matches will be broadcasted via RealBridge kibitzer website...

<https://kibitz.realbridge.online/>

- At the RealBridge kibitzer website, you can find the live broadcasted matches and also all the other matches scheduled for broadcast.
- For security reasons, all broadcasted matches will be delayed by 30-45 min.

11. Smoking, Eating and Alcohol, Mobile and electronic devices

We must act as if we were playing these championships "live", therefore, the following is strictly forbidden during play:

- Mobile phones and any other electronic devices, Mobile phones will be collected and there will be a regular check each session by the monitor.
- Eating (even if only biscuits)
- Drinking Alcohol
- Smoking
- Going to the WC without permission
- Talking loudly during or at the end of any board if the player is unhappy about his/her partner's bid, hand play or defense.





Roster - Senior Teams

Egypt

Captain Ayman Azzam
Amr Farrag
Ayman Azzam
Khaled Abaza
Ahmed Zein
Mohamed El Baz
Ashraf Wahdan

Kenya

Captain Bhanumati Shah
Bhanumati Shah
Saleem UD Deen
Samina Ismail
Vimla Virjee
Sumitra Shah

Morocco

Captain Abdellatif Belkouch
Abdellatif Belkouch
Pierre Sibony
Jean Hayet
Guy Cambournac
Hayat Hachimi
Med Said Berrada

Reunion

Captain Philippe Lagache
Philippe Lagache
Jean-Marc Breslaw
Geneviève Vigna
Catherine Aouate
Narguis Huseinali
Christian Giraud

South Africa

Captain Brian Pincus
Brian Pincus
Larry Chemaly
Diniar Minwalla
James Grant
Nicky Bateman
Val Bloom

47th WORLD BRIDGE TEAMS CHAMPIONSHIPS
14th WORLD TRANSNATIONAL OPEN TEAMS

Herning, Denmark • 20 - 31 August, 2025*

*Registration and Opening Ceremony on 19 August





Roster - Mixed Teams

Egypt

Captain Baher Ahmed (NPC)
Manal Sallam
Rita Ghosn
Farida Botrous
Moaz Hammam
Hany Dagher
Ahmed Nayer

Kenya

Captain Sejal Shah
Sejal Shah
Warren Stanley
Kamal Shah
Karima Popat
Raksha Shah
Paresh Shah

Morocco

Captain Tazi Abderrahim
Tazi Abderrahim
Rokia Hamamsi
Fatim Lahlou
Elie Levy
Lamia Benyahia
Richard Bitton

Reunion

Captain Patrick Hamel
Patrick Hamel
Régine Wan Hoi
Marie-Thérèse Boyer
Patrick Schilli
Denise Bauquier
Jean-Luc Neulat

South Africa

Captain Imitiaz Kaprey
Imitiaz Kaprey
Diana Rosslee
Gregory Hingle
Lorraine Weers
Chris Child
Anton Der Kinderen

Tunisia

Captain Mohamed Rebai (NPC)
Halima Mejri
Jalila Ghodhbane
Maissa Farhani
Mohamed Ali Lakdhar
Moez Fourati
Anis Ghodhbane





Roster - Open Teams

Egypt

Captain

Yehia El Shazly

Walid El Ahmady

Reda Amiry

Ahmed Samir

Aly El Selehdar

Ahmed Omran

Ahmed Yousry

Kenya

Captain

Sejal Shah

Sejal Shah

Kamal Shah

Punam Shah

Bijal Shah

Bhanumati Shah

Warren Stanley

Morocco

Captain

Khalil Bensouda

Khalil Bensouda

Andre O'Hana

Said Badri

Mohammed A Ammor

Tariq Sbili

Said Sbili

Reunion

Captain

Christian Giraud

Christian Giraud

Philippe Lagache

Narguis Huseinali

Patrick Hamel

Marie-Thérèse Boyer

Patrick Schilli

South Africa

Captain

Robert Stephens

Robert Stephens

Hennie Fick

Alon Apteker

Craig Gower

Noah Apteker

Neville Eber

Tunisia

Captain

Wissem Belazreg

Wissem Belazreg

Anas Mestiri

Omar Meddeb

Ahmed Medeb

Anis Ghodhbane

Moez Fourati





Roster - Women Teams

Egypt

Captain Ayman Azzam (NPC)
Hoda Soliman
Dina El Awady
Nadia Taymour
Nessreine Hamdy
Nada Moussa
Christina Miami

Kenya

Captain Samina Ismail
Samina Ismail
Sumitra Shah
Samira Soni
Rupal shah
Vina Verjee
Trupti Haria

Morocco

Captain Fatim Lahlou
Fatim Lahlou
Samira Teber
Graziella Nabil
Salwa Ayad
Khadija Marrakchi
Marie Claire O'Hana

South Africa

Captain Tas Nestoridis
Roz Bernstein
Sharon Lang
Vanessa Armstrong
Carol Stanton
Lotte Sorensen
Tas Nestoridis

Tunisia

Captain Hedia Sellami
Hedia Sellami
Ferdous Trabelsi
Jalila Ghodhbane
Maissa Farhani
Halima Mejri
Najeh Linda





RealBridge Playing Instructions

First : Log in , Lobby, at the table and Settings

- 1. To join any RealBridge game you will need a **LINK**
- 2. All the play links will be available on ABF website

https://www.bridgewebs.com/cgi-bin/bwop/bw.cgi?club=abf&pid=display_page24

AND you might also receive it by mail.

- 3. Click the link and you will be redirected to the log on page of our game which looks like the next figure ...

Notice that your video should appear in the right bottom corner of the page and mic volume showing that it works.

- 4. If you can't see your video then you need to allow your browser to use your cam and mic, do as follows to allow it

- 5. From Goggle Chrome and just before the address bar, press the lock icon

- 6. Allow cam and allow mic.

- 7. Write your name in the required field and press login – nothing else is to be done- **NO ID number will be used, (leave it blank)**

- 8. When you logged in you will see the lobby which almost looks like the following figure (**but this figure includes extra buttons for TDs**)

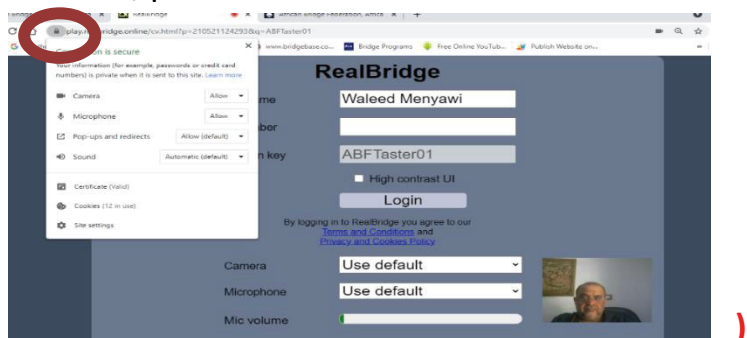
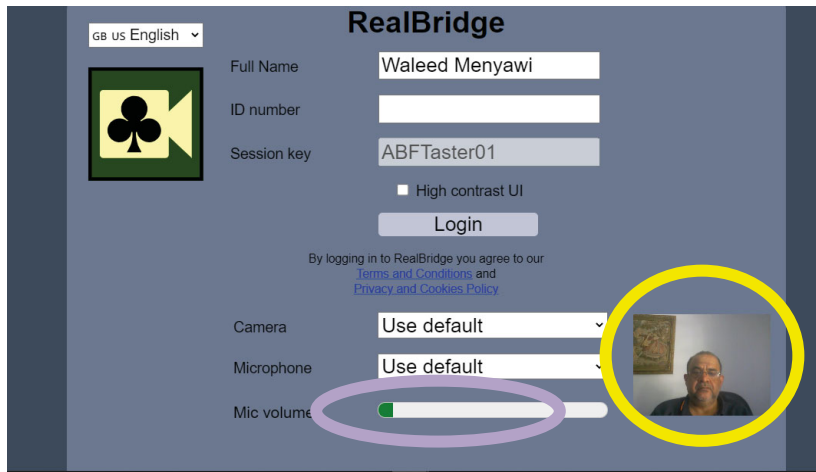

Notice the lobby chat window to the right.

Keep an eye to the Lobby chat ... - For important announcements

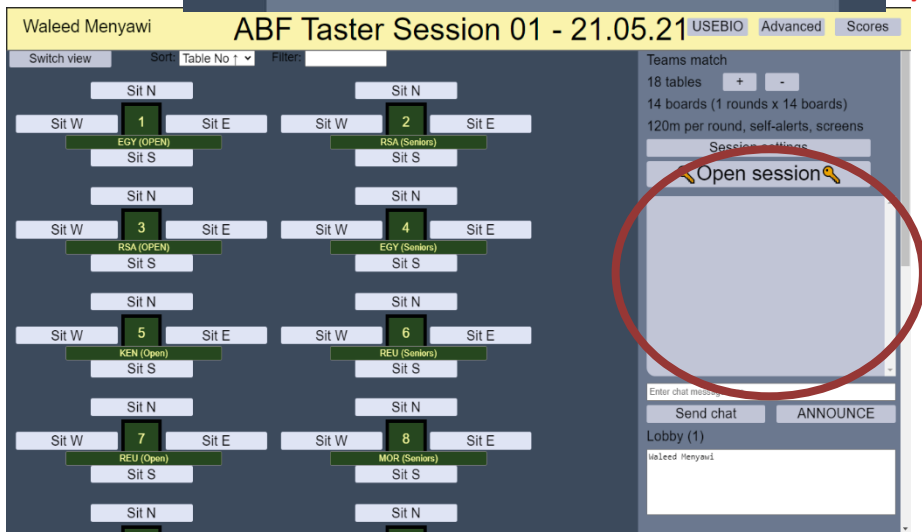



13th African Bridge Championships



- 9. Each table labeled with a team name, find your table and chose where to sit (Sit N, Sit S, Sit E or Sit W)
- 10. Get familiar with the buttons at your table and call the TD using the button for help.

Volume control for your partner.

Volume control for left-hand opponent. You have a separate volume control for each player. This only affects what you hear.

Private chat with left-hand opponent. You can chat privately only with the opponents, not partner

Volume control for right-hand opponent.

Private chat with right-hand opponent.

Disable/enable your video.

Disable / enable your microphone. Use this when you're on the phone!

Hide / unhide the other players' videos. Use this if you have a poor connection.

Redial. Restarts audio and video connections. Use it if the connection fails, or if your video or audio gets out of sync.

Settings

Display style

- Detailed cards
- Simplified cards

Deal animation

Slide

Animation duration

[Slider]

As defender, see dummy

- Facing declarer
- Facing me

As declarer, see dummy as

- Vertical suits (facing declarer)
- Horizontal hand

Input style

- One click or tap
- Two taps (tablet)
- Double click (mouse)

OK Cancel

"Detailed cards" shows pictures of cards; "Simplified cards" are schematic and have larger symbols

The orientation of dummy's cards when you are defending.

The orientation of dummy's cards when you are declaring.

Choose the way you make bids and plays. With "Two taps", the first tap selects the card, then the second tap confirms. "Double click" means that you make two fast clicks.

This controls how a new hand arrives at the beginning of each deal. Choose an effect, or set to "None" to have the hand simply appear.

If you have an animation enabled, use the slider to control how long the animation lasts.





13th African Bridge Championships



11. After we play all boards

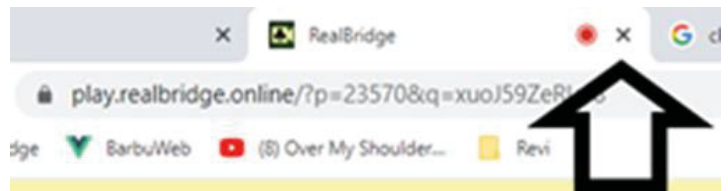

Leave RealBridge, close the tab. See the small X? just click it.



12. Can Use and Can't use

Can Use	Can't use
<ul style="list-style-type: none"> • Windows laptop • Windows desktop • MacBook or another Apple laptop • iMac or another Apple desktop • Chromebook 	<ul style="list-style-type: none"> • Smartphone • Old iPads, older than 2018.

You must use one of these web browsers (you probably are using one of them!):

Can Use ü	Can't use û
<p>Edge, Chrome, Firefox, Safari. The logo must look like one of these – exactly as below. If it looks different, you are using an out-of-date version. <i><u>If you are choosing amongst your browsers, we advise that you chose something other than Firefox.</u></i></p>	<p>Internet Explorer (notice the gold band) The old EDGE (see shape of the e)</p>
	

Second : Bidding, Play, Alert and System

13. **At the start** of any session, All the team members are required to be seated at the same table (Table with the **team name label**), the system will automatically move the EW pairs to the opponents table when we start the session **and will send them back to their home table when both tables finish playing the boards.**

14. **Private chat and Table chat**

- It is strongly recommended to use the chat rather than the vocal chat; the TDs will not take into consideration any vocal explanation if you have any case.
- I will show you now, 2 figures and will appoint to you where to find the table chat (where the 4 players can see your chat) and where to find the private chat where you can chat privately with one of your opponents (not your partner of-course 😊).





13th African Bridge Championships

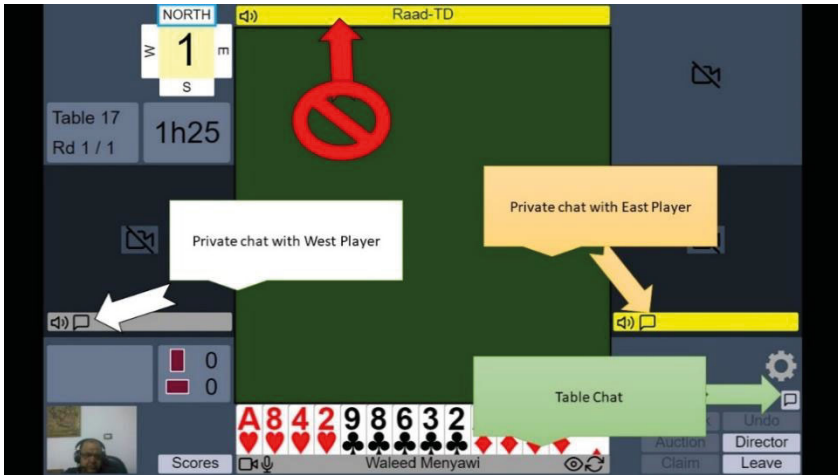

When you are at Full Screen mode

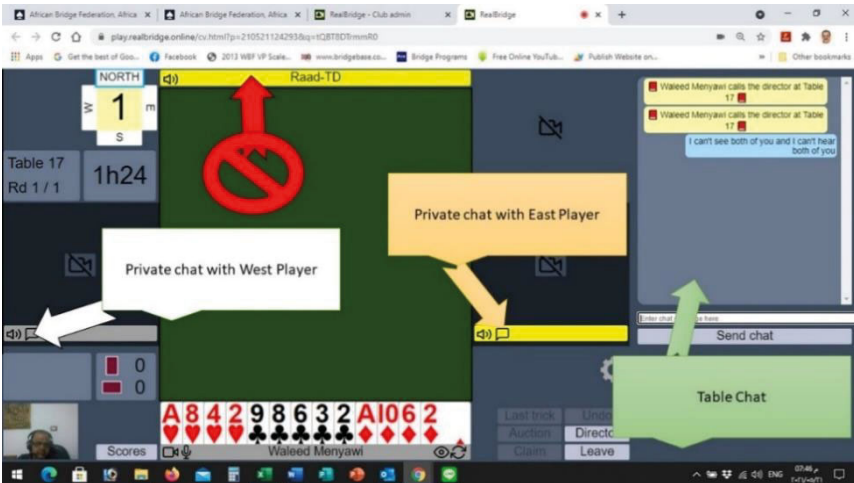

When you are at normal view (NOT Full Screen mode

15. Self-alert and self-explanation proper procedure:

1. Click alert (if required)
2. Write / Put in explanation
3. Make bid

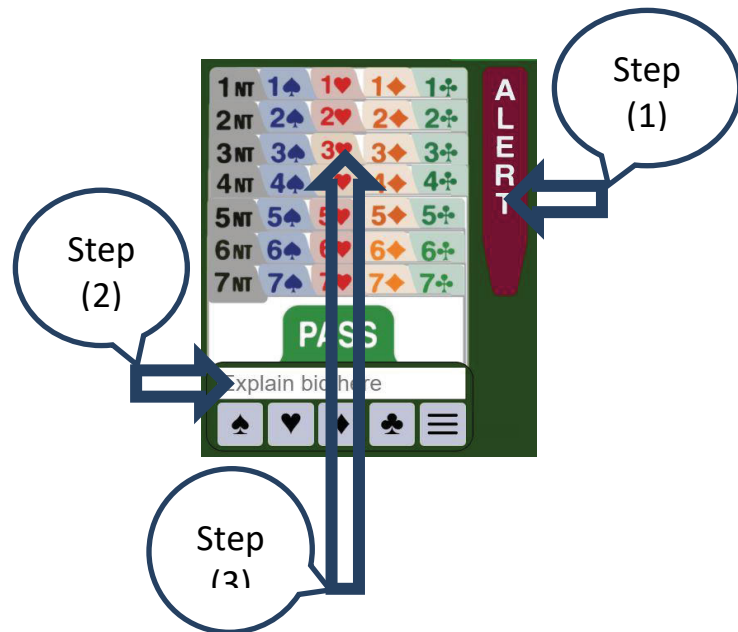



If you make a **mistake** or need to **explain your bid further** after you have bid, you can click on the bid and add more text.

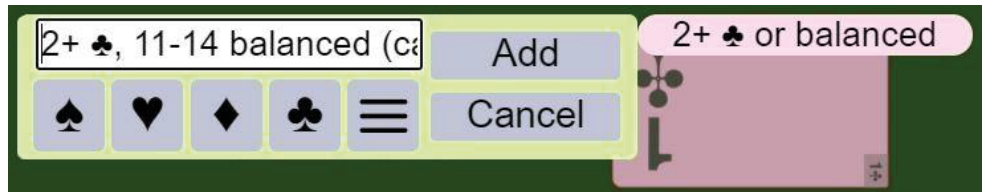

The added text will appear after an asterisk *. The time in seconds between when the bid was **made** and the added explanation was **submitted** is presented after the added text in the square brackets, for this example, 26 seconds. The character limit on explanations is 200 characters.

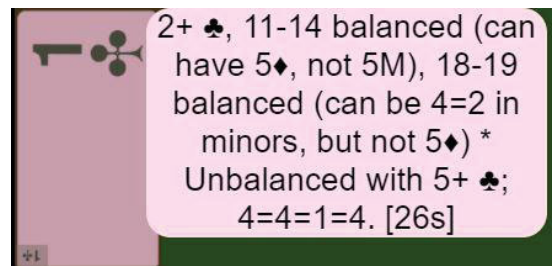

16. System

All teams are required to write a brief about their system at the table chat box before the start of first board in each match.

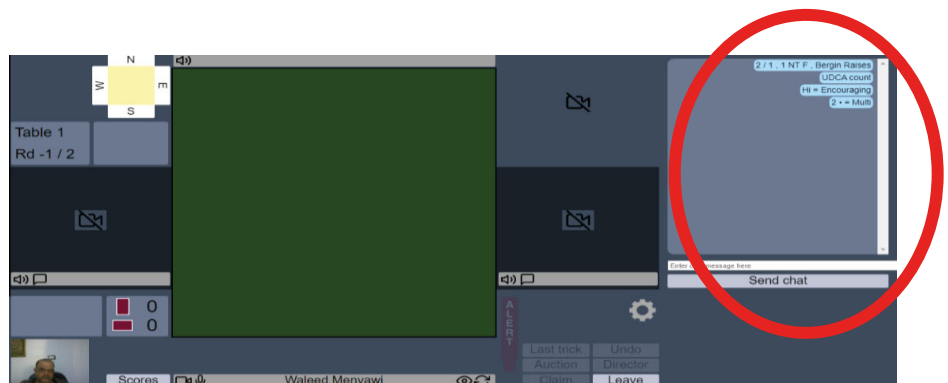



How to load your system card (convention card)

Step 1

Copy the link to your system card/convention card from where it is on the web, like this:

- Find your card.
- Click the **Copy Link** button next to the system card name.

Team	Link to card	Added/Updated	Copy link
CALEDONIA	CC Sam Patsch & Jen Middleton.pdf	18 Apr 2025 21:24	Copy link
CALEDONIA	McQuaker-McGowan WBF 2025.pdf	8 Apr 2025 21:13	Copy link
CALEDONIA	adamson mlina wbf Feb 2025.pdf	5 Apr 2025 17:08	Copy link
CASTELS	Hoja de convenciones Maria Manilla- Laura Casella 2024-2025.pdf	10 Apr 2025 11:07	Copy link

Step 2

When sitting at the table, click the System Card/Convention Card icon to the right of your grey name-band at the bottom of the window.

This box appears:



Step 3 Paste your system card/convention card link into the box. To paste the link:

- On Windows, right-click in the box. Then do **Paste**.
- On a Mac, hold down **Ctrl** and click in the box. Then do **Paste**.
- On an iPad, long-press in the box. Then do **Paste**.

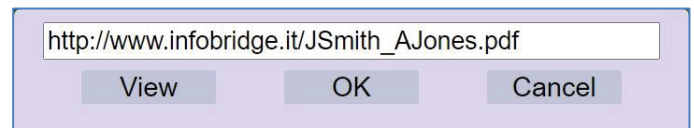
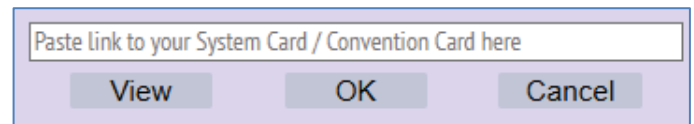

Click OK.

