

African Bridge Federation



13th ♠♥♦♣

African Bridge Championships

Online - 2025

From April 27th To May 10th



RealBridge

Bulletin 1

Monday 28th April

Editor Ron Tacchi

Mixed And Seniors Start The Battle

After the first day of competition in which we started with the Senior and Mixed Championships, Egypt were defending their titles in both events. After the first three sessions of the first Round Robin, Egypt were leading both lists. They are the only unbeaten teams in the competition.

In the Seniors, **Reunion** and **Morocco** are behind **Egypt** with **South Africa** in fourth place a match behind the leaders.

In the Mixed, **Egypt** have amassed nearly 17 VPs per match, the three teams behind are nearly a match adrift and only two points separate **Morocco**, **Tunisia** and **South Africa**.

Standings

Mixed Team	VPs	Position
Egypt	50.27	1
Morocco	33.73	2
Tunisia	32.32	3
South Africa	31.39	4
Reunion	23.16	5
Kenya	8.63	6

Senior Team	VPs	Position
Egypt	45.97	1
Reunion	40.64	2
Morocco	36.69	3
South Africa	25.15	4
kenya	7.55	5

For all information use QR Code
or the website:

www.bridgewebs.com/abf/

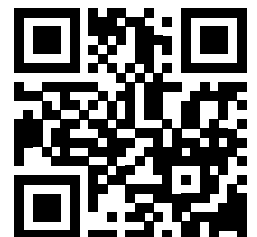



Session 1 - Egypt Starts Defence

For the first session I decided to watch both Egyptian teams as they were the zonal champions two years ago. I shall start with the Seniors who played against Kenya. On the first board one of the Kenyans made an unfortunate mistake (perhaps a misclick?) when the opening bid was passed with a hand containing thirteen points.

Board 6. Dealer East. E/W Vul.

♠ 8654			
♥ 765			
♦ 982			
♣ A64			
♠ 72		♠ AKJ9	
♥ 3		♥ KQ10942	
♦ AQJ763		♦ —	
♣ KJ103		♣ 972	
	♠ Q103		
	♥ AJ8		
	♦ K1054		
	♣ Q85		

Open Room

West	North	East	South
<i>Bhanumati</i>	<i>Wahdan</i>	<i>Shah</i>	<i>Elbaz</i>
–	–	1♥	Double
2♦	Pass	2♥	Pass
3♣	All Pass		

The Kenyan convention card can best be described as sparse so no indication if the Two Diamonds bid was game forcing but I think the Three Clubs bid would be unconditionally forcing to game in my partnership. Three Clubs can be made with an overtrick double dummy but declarer was happy enough to record nine tricks.

Closed Room

West	North	East	South
<i>Zein</i>	<i>Esmail</i>	<i>Abaza</i>	<i>Deen</i>
–	–	1♠	Double
Redble	1♠	Double	1NT
Pass	Pass	2♥	Pass
3NT	All Pass		

I am not a fan of South's Double but there are many who will disagree with me. The Double of

One Spade is penalty orientated and finally West took the advice of a well-known world champion and just bid 3NT. North believing that his partner must have a suit (he obviously did not have spades) tried a top of nothing ♦9 upon which South, perhaps unwisely played the king. Declarer took this trick and played a heart to the ♥10 which lost to South's jack. South now made the unfortunate return of the ♦10 and so West now calmly cashed five more diamonds and ended up with an overtrick and 11 IMPs.

Board 7. Dealer South. All Vul.

♠ 32			
♥ Q86			
♦ AQ973			
♣ 984			
♠ A1087		♠ Q954	
♥ A		♥ J95432	
♦ K82		♦ —	
♣ AKJ102		♣ 765	
	♠ KJ6		
	♥ K107		
	♦ J10654		
	♣ Q3		

Open Room

West	North	East	South
<i>Bhanumati</i>	<i>Wahdan</i>	<i>Shah</i>	<i>Elbaz</i>
–	–	–	Pass
1♣	1♦	Pass	3♦
All Pass			

After a daring vulnerable overcall by North his partner's pre-emptive raise inhibited West from further action with his nineteen count. Declarer took a wrong view in the trump suit and finished down two but this was but a scratch as the opposition can make a vulnerable game.

Closed Room

West	North	East	South
<i>Zein</i>	<i>Esmail</i>	<i>Abaza</i>	<i>Deen</i>
–	–	–	Pass
1♣	Pass	Pass	1♦
1♠	2♦	2♠	3♦
4♠	All Pass		





13th African Bridge Championships



I wonder if South is now regretting his balancing in the fourth seat. On the lead of the ace of diamonds declarer ruffed in dummy and immediately played the queen of trumps, covered by the king and ace. A diamond was now ruffed before another round of trumps was won by South who switched to a heart. Declarer now drew the last trump and when the queen of clubs was doubleton claimed twelve tricks and 10 IMPs.

Board 15. Dealer South. N/S Vul.

<p>♠ 8632 ♥ A5 ♦ A98754 ♣ 5</p>	<table border="1" style="background-color: #4CAF50; color: white; width: 60px; height: 60px; margin: auto;"> <tr><td></td><td>N</td><td></td></tr> <tr><td>W</td><td></td><td>E</td></tr> <tr><td></td><td>S</td><td></td></tr> </table>		N		W		E		S		<p>♠ K7 ♥ J7432 ♦ QJ62 ♣ J9</p>	<p>♠ 104 ♥ KQ ♦ 103 ♣ KQ108642</p> <p>♠ AQJ95 ♥ 10986 ♦ K ♣ A73</p>
	N											
W		E										
	S											

Open Room

West	North	East	South
<i>Bhanumati</i>	<i>Wahdan</i>	<i>Shah</i>	<i>Elbaz</i>
-	-	-	1♠
2♦	Double	Pass	2♥
Pass	3♣	3♦	4♣
Pass	5♣	All Pass	

If Five Clubs makes then Five Diamonds is a good save. As you can see Five Clubs is a simple matter with the king of spades being onside doubleton and no other misfortunes affecting declarer.

Closed Room

West	North	East	South
<i>Zein</i>	<i>Esmail</i>	<i>Abaza</i>	<i>Deen</i>
-	-	-	1♠
Pass	2♣	Pass	2♥
Pass	3NT	All Pass	

By not overcalling West did not advertise to the opposition their weakness in the diamond suit and when East found the opening lead of the queen of diamonds declarer lost the first seven tricks and also 14 IMPs.

Board 16. Dealer West. E/W Vul.

<p>♠ AQ9642 ♥ 73 ♦ Q64 ♣ A4</p>	<table border="1" style="background-color: #4CAF50; color: white; width: 60px; height: 60px; margin: auto;"> <tr><td></td><td>N</td><td></td></tr> <tr><td>W</td><td></td><td>E</td></tr> <tr><td></td><td>S</td><td></td></tr> </table>		N		W		E		S		<p>♠ 5 ♥ KQJ954 ♦ KJ98 ♣ Q6</p> <p>♠ KJ7 ♥ 10862 ♦ A52 ♣ K98</p>	<p>♠ 1083 ♥ A ♦ 1073 ♣ J107532</p>
	N											
W		E										
	S											

Open Room

West	North	East	South
<i>Bhanumati</i>	<i>Wahdan</i>	<i>Shah</i>	<i>Elbaz</i>
1♠	2♥	3♠	Pass
4♠	All Pass		

Mr Meckstroth is well known for his saying "If partner freely supports your six-card major, bid game" and here West had obviously heard of it. On the lead of the king of hearts South had to win with his ace and then returned a club. Declarer now took his chance in the diamond suit by leading towards the queen, now the defence had four tricks, two hearts and two diamonds, one off.

Closed Room

West	North	East	South
<i>Zein</i>	<i>Esmail</i>	<i>Abaza</i>	<i>Deen</i>
1♠	2♥	3♥	Pass
4♠	All Pass		

The same lead and return saw declarer eliminate the club suit and take two rounds of trumps finishing in hand and now made a better choice of playing a heart towards dummy's ♥10. North had to rise with an honour and North was under the illusion that leading a heart would set up a heart trick for declarer and so switched to a diamond, handing declarer his tenth trick. However had he played the ♥9 declarer could have covered in dummy but South could ruff and there would still be two diamonds to lose. Declarer could have done better by taking three rounds of trumps or a prettier ending is to run his trumps and on the penultimate one North has two hearts and three diamonds as does dummy. If North discards a heart the declarer goes to dummy with the ♦A and plays a heart, if he discards a diamond declarer plays ace and another diamond. Another 13 IMPs to Egypt who won 77-4 or a VP whitewash.





13th African Bridge Championships



In the Mixed event Egypt were also playing Kenya.

had declarer played a small club at trick one. 10 IMPs to Egypt.

Board 6. Dealer East. E/W Vul.

		♠ 8654									
		♥ 765									
		♦ 982									
		♣ A64									
♠ 72	<table border="1"> <tr><td></td><td>N</td><td></td></tr> <tr><td>W</td><td></td><td>E</td></tr> <tr><td></td><td>S</td><td></td></tr> </table>		N		W		E		S		♠ AKJ9
		N									
W			E								
		S									
♥ 3		♥ KQ10942									
♦ AQJ763	♦ —										
♣ KJ103	♣ 972										
		♠ Q103									
		♥ AJ8									
		♦ K1054									
		♣ Q85									

Board 7. Dealer South. All Vul.

		♠ 32									
		♥ Q86									
		♦ AQ973									
		♣ 984									
♠ A1087	<table border="1"> <tr><td></td><td>N</td><td></td></tr> <tr><td>W</td><td></td><td>E</td></tr> <tr><td></td><td>S</td><td></td></tr> </table>		N		W		E		S		♠ Q954
		N									
W			E								
		S									
♥ A		♥ J95432									
♦ K82	♦ —										
♣ AKJ102	♣ 765										
		♠ KJ6									
		♥ K107									
		♦ J10654									
		♣ Q3									

Open Room

West	North	East	South
R. Shah	Sallam	P. Shah	Hammam
-	-	1♥	Pass
1NT	Pass	2♥	Pass
2NT	Pass	3♣	All Pass

East does not have an easy bid over 2NT. I am sure if you put this in a bidding panel there would be several different suggestions, East knows West has at least nine cards in the minors so his bid of Three Clubs had been thought through. In this event declarer made all ten tricks available – not easy on a Moysian fit.

Closed Room

West	North	East	South
Ahmed	Stanley	Farida	Sejal
-	-	1♥	Pass
2♦	Pass	2♠	Pass
2NT	Pass	4♥	All Pass

Very aggressive bidding by East came to fruition. I pity poor South having to find a lead from that hand, the choice was a club which was taken by North's ace over dummy's ♣10. The spade return was taken in hand with the ace and a club was won in dummy with the jack. A heart to declarer's king lost to South's ace and a diamond came back and declarer made the slightly strange play of the ace and then ruffing one, playing the queen would have the same effect of getting back to hand and would have gained had South underled his ♦K, as in this case. The queen of trumps was cashed and another played to South's jack. Declarer was now a little fortunate in that when South exited with a club they split 3-3, this would not have been required

Open Room

West	North	East	South
R. Shah	Sallam	P. Shah	Hammam
-	-	-	Pass
1♣	Pass	2♥*	Pass
2NT	Pass	3♣	All Pass

The Two Hearts bid shows a weak hand with six cards and only suitable for playing in that suit, according to the convention card. I would dare to suggest that this hand is suitable for playing in spades, spoiler alert – we might see that in the Closed Room. West showed his powerful hand with his no-trump bid but now the spades were lost and also the chance of the minor-suit game. Declarer took eleven tricks.

Closed Room

West	North	East	South
Ahmed	Stanley	Farida	Sejal
-	-	-	Pass
1♣	Pass	Pass	1♦
Double	2♦	2♥	Pass
2♠	Pass	3♠	Pass
4♠	All Pass		

Another South ruing the balancing in fourth position. Again on the lead of the ace of diamonds declarer was not hard pushed to garner eleven tricks and the same number of IMPs to Egypt.





13th African Bridge Championships



Board 13. Dealer North. All Vul.

♠ AQ72		♠ 4									
♥ K32		♥ J65									
♦ K852		♦ J10743									
♣ 93		♣ 10752									
♠ K8653											
♥ 874											
♦ 96											
♣ AJ8											
	<table border="1" style="width: 40px; height: 40px; margin: auto;"> <tr><td></td><td>N</td><td></td></tr> <tr><td>W</td><td></td><td>E</td></tr> <tr><td></td><td>S</td><td></td></tr> </table>		N		W		E		S		
	N										
W		E									
	S										
		♠ J109									
		♥ AQ109									
		♦ AQ									
		♣ KQ64									

Open Room

West	North	East	South
<i>R. Shah</i>	<i>Sallam</i>	<i>P. Shah</i>	<i>Hammam</i>
-	1♦	Pass	1♥
Pass	1♠	Pass	6NT
All Pass			

Not the world's most scientific auction but expressed declarer's values. Basically the slam depended on the spade finesse and a touch more. Declarer was probably slightly anxious when the lead was a spade but probably regained breathing control when the trick peacefully ran round to the ♠9. Two successful spade finesses followed and then a club was led towards the king. West took his ace and now the game was up as the hearts were good for four tricks. What would declarer have done if West has ducked the club smoothly, and I stress, smoothly. Declarer would have had options, including leading towards the club honour a second time, if you give declarer a chance to go wrong sometimes the chance will be taken.

Closed Room

West	North	East	South
<i>Ahmed</i>	<i>Stanley</i>	<i>Farida</i>	<i>Sejal</i>
-	1♦	Pass	1♥
Pass	1♠	Pass	2♣
Pass	2♥	Pass	4NT
Pass	5♥	Pass	6NT
All Pass			

An altogether more controlled auction to the same spot. Declarer's heart probably jumped with joy when the lead was a heart to the jack and queen followed by the jack of spades being covered by the king. At this point in the proceedings joy may have overtaken care as declarer failed to set up a club trick and then suddenly saw dummy with two

winners but no route to cash them and an unfortunate failure by one trick conceding 17 IMPs to Egypt.

Board 16. Dealer West. E/W Vul.

♠ 5		♠ KJ7									
♥ KQJ954		♥ 10862									
♦ KJ98		♦ A52									
♣ Q6		♣ K98									
♠ AQ9642											
♥ 73											
♦ Q64											
♣ A4											
	<table border="1" style="width: 40px; height: 40px; margin: auto;"> <tr><td></td><td>N</td><td></td></tr> <tr><td>W</td><td></td><td>E</td></tr> <tr><td></td><td>S</td><td></td></tr> </table>		N		W		E		S		
	N										
W		E									
	S										
		♠ 1083									
		♥ A									
		♦ 1073									
		♣ J107532									

Open Room

West	North	East	South
<i>R. Shah</i>	<i>Sallam</i>	<i>P. Shah</i>	<i>Hammam</i>
1♠	2♥	3♥	Pass
3♠	All Pass		

Evidently West is not a student of Mr Meckstroth, which giving that only nine tricks were taken is probably a good thing.

Closed Room

West	North	East	South
<i>Ahmed</i>	<i>Stanley</i>	<i>Farida</i>	<i>Sejal</i>
1♠	2♥	3♥	Pass
4♠	All Pass		

At this table the musings of Mr Meckstroth are better known. Declarer followed my line as described above by taking three rounds of trumps after the heart lead and club switch. Then eliminating the club suit and playing a heart towards dummy. 10 more IMPs to Egypt. Egypt had won 82-5, a white-wash in VPs.

Egypt had started their defence of the Mixed and Seniors in the best way possible with two maximums. Other teams will have to do well to stop them repeating the previous championships.





Schedule for Monday 28th April

Note all times are GMT

Senior Championship

R.R (01)		Match (04), 09H00			Match (05), 12H30			RR(02) Match (01), 15H20		
Date	Table No.	Home Team	X	Visiting Team	Home Team	X	Visiting Team	Home Team	X	Visiting Team
MON 28	1	³ RSA	x	¹ MOR	¹ MOR	x	² EGY	⁶ --	x	¹ MOR
	2	⁴ REU	x	² EGY	³ RSA	x	⁶ --	⁵ KEN	x	² EGY
	3	⁵ KEN	x	⁶ --	⁴ REU	x	⁵ KEN	⁴ REU	x	³ RSA

Mixed Championship

R.R (01)		Match (04), 09H00			Match (05), 12H30			RR(02) Match (01), 15H20		
Date	Table No.	Home Team	X	Visiting Team	Home Team	X	Visiting Team	Home Team	X	Visiting Team
MON 28	4	³ RSA	x	¹ EGY	¹ EGY	x	² TUN	⁶ KEN	x	¹ EGY
	5	⁴ MOR	x	² TUN	³ RSA	x	⁶ KEN	⁵ REU	x	² TUN
	6	⁵ REU	x	⁶ KEN	⁴ MOR	x	⁵ REU	⁴ MOR	x	³ RSA

Results

Mixed Championship

Session 1	VPs
Egypt - Kenya	20-0
Tunisia - Reunion	12.8-7.2
South Africa - Morocco	5.61-14.39
Session 2	
Reunion - Egypt	3.81-16.09
Kenya - Morocco	6.48-13.52
Tunisia - South Africa	1.67-18.33
Session 3	
Egypt - Morocco	14.18-5.82
Reunion - South Africa	12.29-7.71
Kenya - Tunisia	2.15-17.85

Senior Championship

Session 1	VPs
Morocco - Bye	0-12
Egypt - Kenya	20.0
South Africa - Reunion	1.67-18.33
Session 2	
Kenya - Morocco	5-15
Bye - Reunion	12-0
Egypt - South Africa	13.97-6.03
Session 3	
Morocco - Reunion	9.69-10.31
Kenya - South Africa	2.55-17.45
Bye - Egypt	0-12





South Africa vs. Tunisia - Mixed

The second session of the first Round Robin in the Mixed event saw South Africa take on Tunisia. Tunisia would be looking to avenge their defeat in the Mixed final in the previous championships, whereas South Africa would be looking to improve on their rather dour first round..

I am also not sure where South expected to make defensive tricks. The opening lead of the ace of clubs followed by a second, ruffed by South was the end of the defence as South had ruffed a club loser so the same eleven tricks were available. 10 IMPs to South Africa.

Board 17. Dealer North. None Vul.

♠ — ♥ K109853 ♦ Q104 ♣ A982	<table style="margin: auto; border: 1px solid green; background-color: #90ee90;"> <tr><td style="padding: 2px;">N</td></tr> <tr><td style="padding: 2px;">W</td></tr> <tr><td style="padding: 2px;">E</td></tr> <tr><td style="padding: 2px;">S</td></tr> </table>	N	W	E	S	♠ 104 ♥ AQ4 ♦ K732 ♣ Q1054	♠ Q652 ♥ J7 ♦ AJ9865 ♣ J
N							
W							
E							
S							

Open Room

West	North	East	South
<i>Halima</i>	<i>Der Kinderen</i>	<i>Lakhdhar</i>	<i>Child</i>
–	1♥	Pass	1♠
2♠	Pass	2NT	3♦
3♠	All Pass		

Could either East or West done more and so get to the unbeatable game, I think you can make a case for both of them but on a different day this might well have been the right decision. After the diamond lead declarer crossed to dummy via a successful heart finesse and played trumps without loss and eventually lost two club tricks.

Closed Room

West	North	East	South
<i>Weers</i>	<i>Goncalves</i>	<i>Kaprey</i>	<i>Ghodhbane</i>
–	2♦*	Pass	2♥*
3♠	4♥	Pass	Pass
4♠	Pass	Pass	Double
All Pass			
2♦	Multi, weak only		
2♥	Pass or correct		

The multi made it easier for West, though I am a little surprised at East not raising to the four-level.

Board 21. Dealer North. N/S Vul.

♠ 10982 ♥ J2 ♦ J5 ♣ A10983	<table style="margin: auto; border: 1px solid green; background-color: #90ee90;"> <tr><td style="padding: 2px;">N</td></tr> <tr><td style="padding: 2px;">W</td></tr> <tr><td style="padding: 2px;">E</td></tr> <tr><td style="padding: 2px;">S</td></tr> </table>	N	W	E	S	♠ 64 ♥ 1086 ♦ 8432 ♣ Q652	♠ J753 ♥ 43 ♦ AK96 ♣ K74
N							
W							
E							
S							

Open Room

West	North	East	South
<i>Halima</i>	<i>Der Kinderen</i>	<i>Lakhdhar</i>	<i>Child</i>
–	Pass	Pass	1♦
Double	Pass	1♥	Pass
4♥	All Pass		

I can imagine the look on declarer's face when the tray came back with the Four Hearts card facing him. Declarer was not fortunate in that the defence cashed the ace and king of diamonds and then took a diamond ruff before cashing the ace of clubs for one off.

Closed Room

West	North	East	South
<i>Weers</i>	<i>Goncalves</i>	<i>Kaprey</i>	<i>Ghodhbane</i>
–	Pass	Pass	1♦
Double	1♠	Pass	2♠
4♥	All Pass		

North found the good lead of the jack of diamonds but when South won with the king switched to a spade and now declarer could draw trumps and establish a diamond trick by force. Ten tricks and 10 IMPs to South Africa.





13th African Bridge Championships



Board 23. Dealer South. All Vul.

♠ J85		♠ KQ7									
♥ 86		♥ KJ732									
♦ AKQ97		♦ 53									
♣ 975		♣ J106									
♠ 2											
♥ Q954											
♦ J1084											
♣ KQ83											
	<table border="1" style="width: 50px; height: 50px; margin: auto;"> <tr><td></td><td>N</td><td></td></tr> <tr><td>W</td><td></td><td>E</td></tr> <tr><td></td><td>S</td><td></td></tr> </table>		N		W		E		S		
	N										
W		E									
	S										
♠ A109643											
♥ A10											
♦ 62											
♣ A42											

Open Room

West	North	East	South
<i>Halima</i>	<i>Der Kinderen</i>	<i>Lakhdhar</i>	<i>Child</i>
-	-	-	1♠
Pass	1NT*	Pass	2♠
Pass	3♠	Pass	4♠
All Pass			
1NT	F1R		

Another shout out to Mr Meckstroth, he is having a busy day today. The Three Spade bid after the forcing 1NT showed that awkward hand in the 10-11 three-card raise. With little to go on from the bidding West elected to start with the jack of diamonds, won in dummy. The lead of the ♠8 did not provoke a cover from East and when declarer let it run it held the trick and now declarer had ten top tricks.

Closed Room

West	North	East	South
<i>Weers</i>	<i>Goncalves</i>	<i>Kaprey</i>	<i>Ghodhbane</i>
-	-	-	1♠
Pass	1NT*	Pass	2♠
Pass	3♠	Pass	4♠
All Pass			
1NT	F1R		

The same auction, this time West led a heart and now declarer played ace and another trump, a 65% chance of only losing one trump trick, the double finesse has a 76% chance of success, so was that the better choice? I cannot definitely say yes as there are other factors here. For the double finesse to work you need two entries to dummy and they are only via the diamond suit. Now you must decide whether the third round of diamonds will stand up and you may also give up on overtricks if the diamonds are splitting evenly. I think it is a coin toss as to which is the better line, all I can say is

that had I been declarer I would have gone down in the contract. After the jack of diamonds lead there is one other line, take the ace of trumps and then finesse against the ♦10 and then just play diamonds, Will work against any trump distribution. The result was 12 IMPs to Egypt.

Board 26. Dealer East. All Vul.

♠ 97		♠ AQJ63									
♥ AJ754		♥ K986									
♦ Q87		♦ J52									
♣ J108		♣ 7									
♠ 10852											
♥ Q32											
♦ 93											
♣ KQ96											
	<table border="1" style="width: 50px; height: 50px; margin: auto;"> <tr><td></td><td>N</td><td></td></tr> <tr><td>W</td><td></td><td>E</td></tr> <tr><td></td><td>S</td><td></td></tr> </table>		N		W		E		S		
	N										
W		E									
	S										
♠ K4											
♥ 10											
♦ AK1064											
♣ A5432											

Open Room

West	North	East	South
<i>Halima</i>	<i>Der Kinderen</i>	<i>Lakhdhar</i>	<i>Child</i>
-	-	1♠	2NT*
3♠	All Pass		
2NT	minors		

A sensible auction to a sensible contract. The cards were not well-placed for declarer. The opening king of diamonds lead saw a shift to a heart taken by North's ace and the heart return ruffed by South who then cashed his two aces before exiting with a club. Declarer now naturally took the spade finesse to finish two light.

Closed Room

West	North	East	South
<i>Weers</i>	<i>Goncalves</i>	<i>Kaprey</i>	<i>Ghodhbane</i>
-	-	1♠	2NT*
3♠	4♣	Pass	5♣
Double	All Pass		
2NT	minors		

When North freely entered the auction South with his five loser hand went for gold. West had other ideas and produced a red card. The ace of spades was led and a diamond continued won in hand, the jack of clubs lost to the queen. A heart came back to declarer's ace who made the error of leading the ♦10 thus ensuring two further trump losers. To hold his losers to one he needed to cross to dummy and play a small trump towards his ♣10. So two off and 12 IMPs to South Africa.





13th African Bridge Championships



Board 31. Dealer South. N/S Vul.

♠ 6 ♥ QJ ♦ K732 ♣ QJ8762	<div style="background-color: #008000; color: white; padding: 5px; display: inline-block;"> N W E S </div>	♠ K1042 ♥ A ♦ 109654 ♣ K103	♠ J7 ♥ K1076543 ♦ J ♣ 954
-----------------------------------	--	--------------------------------------	------------------------------------

Open Room

West	North	East	South
<i>Halima</i>	<i>Der Kinderen</i>	<i>Lakhdhar</i>	<i>Child</i>
-	-	-	3♥
Double	Pass	4♥	Pass
4♠*	Pass	4NT	Pass
5♣	Pass	5♦*	Pass
6♠	All Pass		
5♦	Queen ask		

I think the alert of 4♠ was actually a misplaced alert on 4♥ but it does not matter. It was a good and successful auction. Declarer was not unduly tested in the play just drew trumps and tried the diamond finesse for plus one, the good news it did not work so no possibility of a rogue grand slam making.

Closed Room

West	North	East	South
<i>Weers</i>	<i>Goncalves</i>	<i>Kaprey</i>	<i>Ghodhbane</i>
-	-	-	3♥
3♠	Pass	4♠	All Pass

The Double as West's initial bid will always be more successful than just a Three Spades bid. West's hand could be considerably weaker for that bid. The test is, in my opinion, quite simple, do you want to play in Four Spades almost no matter what? I believe the answer to that question is yes so a Double is better and you will bid 4♠ over whatever partner bids. 11 IMPs to Tunisia.

South Africa ran out 73-31 winners or 18.33-1.67 VPs giving them a total over the first two matches of 24 VPs.

Local Time

All times quoted within the Bulletins are GMT:

Morocco and Tunisia are one hour ahead.

South Africa is two hours ahead.

Egypt and Kenya are three hours ahead and

Reunion is four hours ahead.

So at 2.00 p.m. it is 3.00 p.m. in Morocco and Tunisia, 4.00 p.m. in South Africa and 5.00 p.m in Egypt, and Kenya and 6.00 p.m. in Reunion.





Championship Information

Your Chief Tournament Director Waleed El Menyawi explains the important procedures to be observed during the Championships:

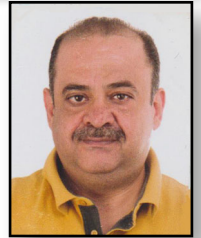

The Followings are some important information from your Head TD which need to be carefully read by each member, captain or coach of any team, please refer to the [Conditions of Contest](#) for full details.

1. Play Format: Open, Women, Seniors & Mixed teams

1. Three Complete RR (15 Matches X 16 Boards each; in 5 days)
2. The top four teams will qualify to the Semi-final stage, the first ranked team will choose its opponents from between teams ranked 3rd or 4th.
3. Semi-Final will be five Segments of 16 Boards each, No Carry Over (Check the [CoC](#) for tie-breaks).
4. For the Semi-final, Final and play-off sessions, It has been decided that:
5. - The team ranked higher after the RR stage will be the Home team in segments 3 & 5 in the Semi-final.
6. - The team ranked lower after the RR stage will be the Home team in segments 2 & 4 in the Semi-Final.
7. - The 1st Segment will be blind line up.
8. - The team ranked higher after the RR stage will be the Home team in segment 3 in the Final or Play-off.
9. - The team ranked lower will be the Home team in Segment 2 while segment 1 will be blind.
10. The Final will be three Segments of 14 Boards each, No Carry Over (Check the [CoC](#) for tie-breaks).
11. The first 2 RR will be home and away line-ups.
12. The last Round Robin shall be done according to the final ranking of the teams in the previous played 2 rounds and will be a blind line-up.

2. Teams Events ... Last RR

The last Round Robin for all categories shall be done according to the final ranking of the teams in the previous played rounds.

3. Please click the link below for instructions

[Alert Procedures - Undo Procedures - General Instructions](#)

Note that : « Systems Policy Change: Please note that as of January 1st 2025 the use of a written defence against the Multi 2 Diamonds (or 2 Clubs) is no longer permitted in WBF events

5. Play instructions and Schedule of play ...

A. When you log on to the RealBridge game (using the game link), you will find your team





name written in one of the Tables.

B. All team members are required to sit at their table (all together) in Pairs NS and EW, later on, when we start the session, the software will automatically move the EW pairs between the tables according to the schedule of play.

C. In the schedule of play you will find Home team (the team mentioned first) and Visiting team (the team mentioned second)

D. The visiting team has to sit first at their table (Pairs NS and EW) and the Home team has the right to have a look at the visiting team and sit its pairs accordingly.

6. Request a review

1. First step is to review the TD ruling with the Head TD

2. Second step is apply for an official review by submitting a review form through the TD in charge of your case.

3. A request for a review of a Tournament Director's ruling must be lodged within 30 minutes of the first posting of the official score for the Session in which the board was played that is the subject of the ruling. All such requests must be lodged by the team's Captain or his designee, or by one member of the pair in the Pairs events.

4. When lodging a Request for Review the appellant must make a monetary deposit with the ABF monitor. The amount of deposit required will be US \$ 100 (or the equivalent in Euro)

5. The case will be reviewed by a person who was not involved in the original decision. The Reviewer will check that the TD has gathered the necessary evidence of what occurred when the infraction arose. The Reviewer will then need to be satisfied that the correct law was applied and that other TDs were consulted where appropriate. In matters involving the judgement that was exercised by a player following unauthorized information, incorrect explanation or failure to alert, the Reviewer will clarify that suitable players have been asked appropriate questions to enable a judgmental view to be obtained. Finally, the Reviewer will check that the ruling that was issued based upon all the information available to the TDs was within the bounds of reasonableness. The fact that the Reviewer might have determined a slightly different ruling would not be good reason for the ruling to be varied. In the event that the process had not been followed properly in some material way, the Reviewer will ask the Head TD to correct the failings and issue a new ruling.

7. Time delay and hesitation

- It is very important to know that the TDs have the tools to produce a board report which includes the time for each bid / play by each player, so please be bare that in mind when calling the TD for a possible hesitation or before denying it.

- It is also very important to know that the TDs also have the tools to produce a session time report which includes the exact time taken by each player in a session, in case of time delay, the penalty will be given according to this report.

8. Home & Visiting teams

- When you log in to the RealBridge game (using the game link), you will find your team name written on one of the Tables.
- All team members are required to sit at their table (all together) in Pairs NS and EW, later on, when we start the session, the software will automatically move the EW pairs between the tables according to the schedule of play.





13th African Bridge Championships



- In the schedule of play you will find Home team (the team mentioned first) and Visiting team (the team mentioned second)
- NO LINE-UP will be needed from the teams, the visiting team has to sit first at their table (in Pairs NS and EW), minimum 10 min before the official start time, and the Home team has the right to have a look at the visiting team and sit its pairs accordingly.

9. Headphones / Earphones

In order to minimize the noise in the venue as much as possible...

- It is mandatory for each player to have his own headphone / earphone which is connected to his device during play
- Use the table chat / private chat as much as possible and don't use vocal chat.
- Any vocal explanation will not be taken into the TD consideration in any case.
- You need to be very careful when using the table chat as you might give an unauthorized information to your partner which could results in adjusted score by the TD.

10. Kibitzers

- Kibitzers are not allowed by any means at 1) the playing venue, 2) RealBridge online playing room.
- All players are required to immediately leave the playing area when they finish their session, players are also kindly asked to keep their seats and not roam around the playing area.
- All the matches will be broadcasted via RealBridge kibitzer website...

<https://kibitz.realbridge.online/>

- At the RealBridge kibitzer website, you can find the live broadcasted matches and also all the other matches scheduled for broadcast.
- For security reasons, all broadcasted matches will be delayed by 30-45 min.

11. Smoking, Eating and Alcohol, Mobile and electronic devices

We must act as if we were playing these championships "live", therefore, the following is strictly forbidden during play:

- Mobile phones and any other electronic devices, Mobile phones will be collected and there will be a regular check each session by the monitor.
- Eating (even if only biscuits)
- Drinking Alcohol
- Smoking
- Going to the WC without permission
- Talking loudly during or at the end of any board if the player is unhappy about his/her partner's bid, hand play or defense.





Roster - Senior Teams

Egypt

Captain Ayman Azzam
Amr Farrag
Ayman Azzam
Khaled Abaza
Ahmed Zein
Mohamed El Baz
Ashraf Wahdan

Kenya

Captain Bhanumati Shah
Bhanumati Shah
Saleem UD Deen
Samina Ismail
Vimla Virjee
Sumitra Shah

Morocco

Captain Abdellatif Belkouch
Abdellatif Belkouch
Pierre Sibony
Jean Hayet
Guy Cambournac
Hayat Hachimi
Med Said Berrada

Reunion

Captain Philippe Lagache
Philippe Lagache
Jean-Marc Breslaw
Geneviève Vigna
Catherine Aouate
Narguis Huseinali
Christian Giraud

South Africa

Captain Brian Pincus
Brian Pincus
Larry Chemaly
Diniar Minwalla
James Grant
Nicky Bateman
Val Bloom

47th WORLD BRIDGE TEAMS CHAMPIONSHIPS
14th WORLD TRANSNATIONAL OPEN TEAMS
 Herning, Denmark • 20 - 31 August, 2025* *Registration and Opening Ceremony on 19 August





Roster - Women Teams

Egypt

Captain Ayman Azzam (NPC)
Hoda Soliman
Dina El Awady
Nadia Taymour
Nessreine Hamdy
Nada Moussa
Christina Miami

Kenya

Captain Samina Ismail
Samina Ismail
Sumitra Shah
Samira Soni
Rupal shah
Vina Verjee
Trupti Haria

Morocco

Captain Fatim Lahlou
Fatim Lahlou
Samira Teber
Graziella Nabil
Salwa Ayad
Khadija Marrakchi
Marie Claire O'Hana

South Africa

Captain Tas Nestoridis
Roz Bernstein
Sharon Lang
Vanessa Armstrong
Carol Stanton
Lotte Sorensen
Tas Nestoridis

Tunisia

Captain Hedia Sellami
Hedia Sellami
Ferdous Trabelsi
Jalila Ghodhbane
Maissa Farhani
Halima Mejri
Najeh Linda





RealBridge Playing Instructions

First : Log in , Lobby, at the table and Settings

- 1. To join any RealBridge game you will need a **LINK**
- 2. All the play links will be available on ABF website

https://www.bridgewebs.com/cgi-bin/bwop/bw.cgi?club=abf&pid=display_page24

AND you might also receive it by mail.

- 3. Click the link and you will be redirected to the log on page of our game which looks like the next figure ...

Notice that your video should appear in the right bottom corner of the page and mic volume showing that it works.

- 4. If you can't see your video then you need to allow your browser to use your cam and mic, do as follows to allow it

- 5. From Goggle Chrome and just before the address bar, press the lock icon

- 6. Allow cam and allow mic.

- 7. Write your name in the required field and press login – nothing else is to be done- **NO ID number will be used, (leave it blank)**

- 8. When you logged in you will see the lobby which almost looks like the following figure (**but this figure includes extra buttons for TDs**)

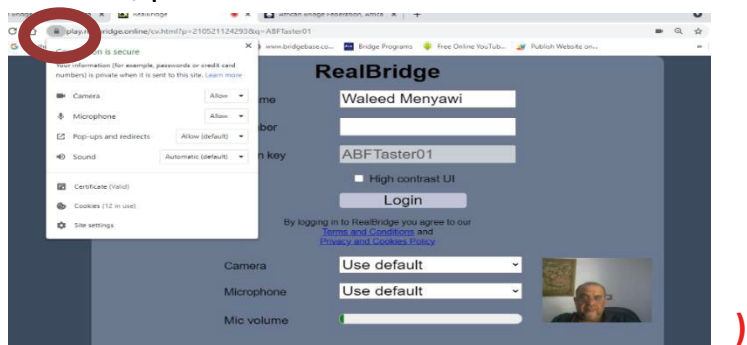
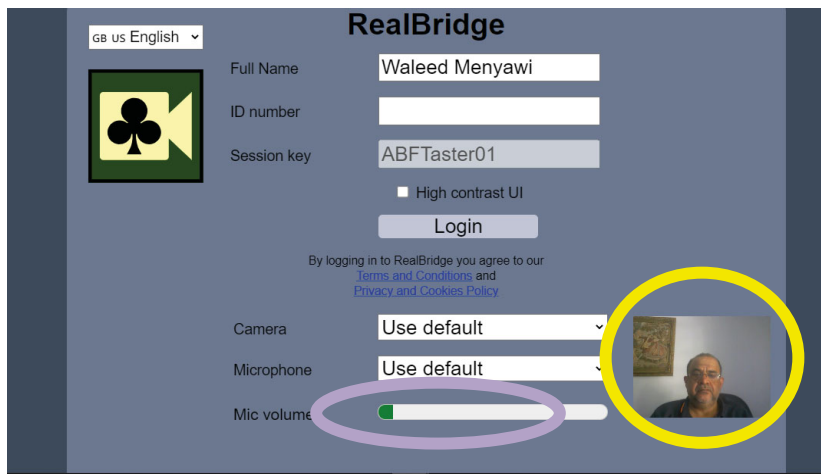

Notice the lobby chat window to the right.

Keep an eye to the Lobby chat ... - For important announcements





13th African Bridge Championships



- 9. Each table labeled with a team name, find your table and chose where to sit (Sit N, Sit S, Sit E or Sit W)
- 10. Get familiar with the buttons at your table and call the TD using the button for help.

Volume control for your partner.

Volume control for left-hand opponent. You have a separate volume control for each player. This only affects what you hear.

Private chat with left-hand opponent. You can chat privately only with the opponents, not partner

Volume control for right-hand opponent.

Private chat with right-hand opponent.

Disable/enable your video.

Disable / enable your microphone. Use this when you're on the phone!

Hide / unhide the other players' videos. Use this if you have a poor connection.

Redial. Restarts audio and video connections. Use it if the connection fails, or if your video or audio gets out of sync.

Settings

- Display style**
 - Detailed cards
 - Simplified cards

"Detailed cards" shows pictures of cards; "Simplified cards" are schematic and have larger symbols
- Deal animation**
 - Slide

This controls how a new hand arrives at the beginning of each deal. Choose an effect, or set to "None" to have the hand simply appear.
- As defender, see dummy**
 - Facing declarer
 - Facing me

The orientation of dummy's cards when you are defending.
- As declarer, see dummy as**
 - Vertical suits (facing declarer)
 - Horizontal hand

The orientation of dummy's cards when you are declaring.
- Input style**
 - One click or tap
 - Two taps (tablet)
 - Double click (mouse)

Choose the way you make bids and plays. With "Two taps", the first tap selects the card, then the second tap confirms. "Double click" means that you make two fast clicks.
- Animation duration**
 - [Slider]

If you have an animation enabled, use the slider to control how long the animation lasts.

OK Cancel





13th African Bridge Championships



11. After we play all boards

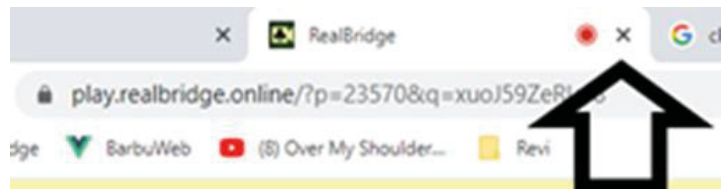

Leave RealBridge, close the tab. See the small X? just click it.



12. Can Use and Can't use

Can Use	Can't use
<ul style="list-style-type: none"> • Windows laptop • Windows desktop • MacBook or another Apple laptop • iMac or another Apple desktop • Chromebook 	<ul style="list-style-type: none"> • Smartphone • Old iPads, older than 2018.

You must use one of these web browsers (you probably are using one of them!):

Can Use ü	Can't use û
<p>Edge, Chrome, Firefox, Safari. The logo must look like one of these – exactly as below. If it looks different, you are using an out-of-date version. <i><u>If you are choosing amongst your browsers, we advise that you chose something other than Firefox.</u></i></p>	<p>Internet Explorer (notice the gold band) The old EDGE (see shape of the e)</p>
	

Second : Bidding, Play, Alert and System

13. **At the start** of any session, All the team members are required to be seated at the same table (Table with the **team name label**), the system will automatically move the EW pairs to the opponents table when we start the session **and will send them back to their home table when both tables finish playing the boards.**

14. **Private chat and Table chat**

- It is strongly recommended to use the chat rather than the vocal chat; the TDs will not take into consideration any vocal explanation if you have any case.
- I will show you now, 2 figures and will appoint to you where to find the table chat (where the 4 players can see your chat) and where to find the private chat where you can chat privately with one of your opponents (not your partner of-course 😊).



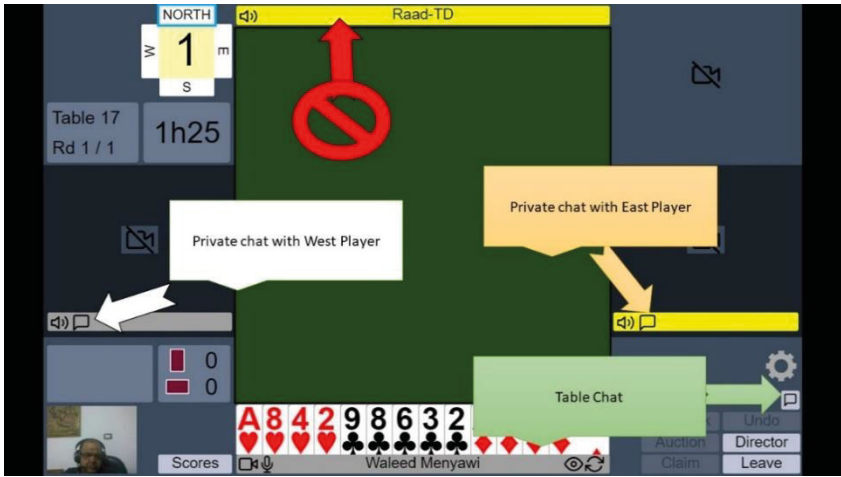

When you are at Full Screen mode

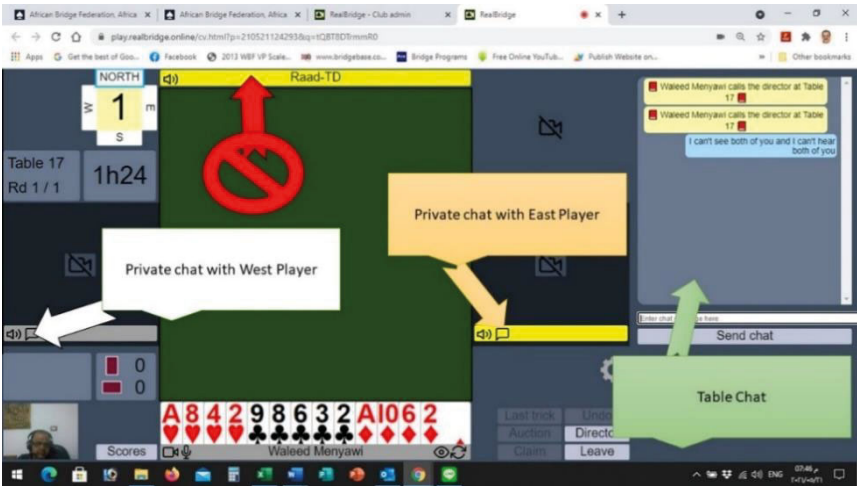

When you are at normal view (NOT Full Screen mode

15. Self-alert and self-explanation proper procedure:

1. Click alert (if required)
2. Write / Put in explanation
3. Make bid

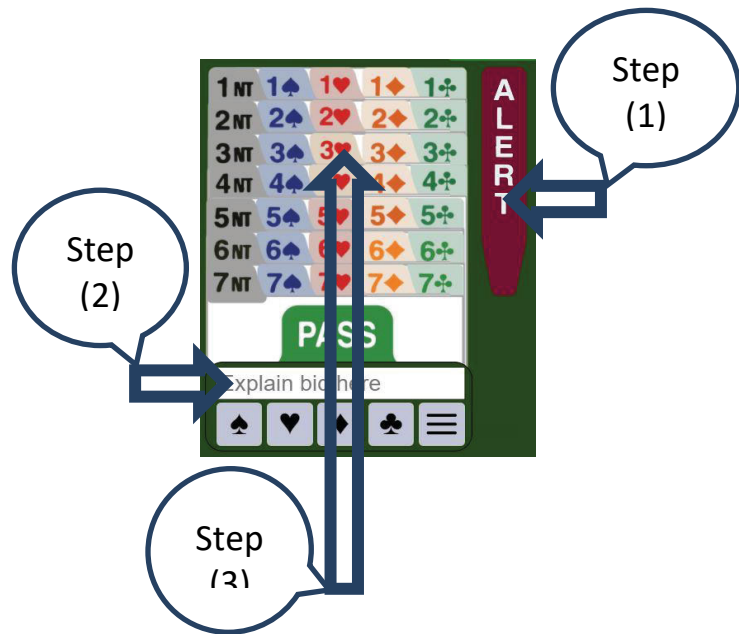



If you make a **mistake** or need to **explain your bid further** after you have bid, you can click on the bid and add more text.

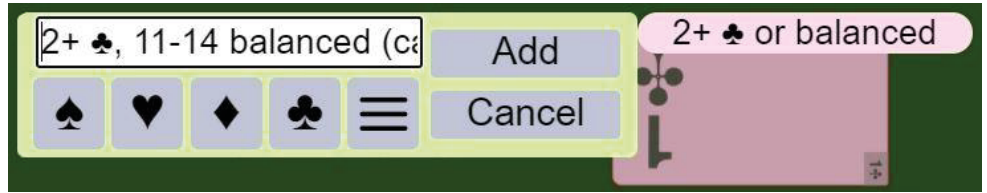

The added text will appear after an asterisk *. The time in seconds between when the bid was **made** and the added explanation was **submitted** is presented after the added text in the square brackets, for this example, 26 seconds. The character limit on explanations is 200 characters.

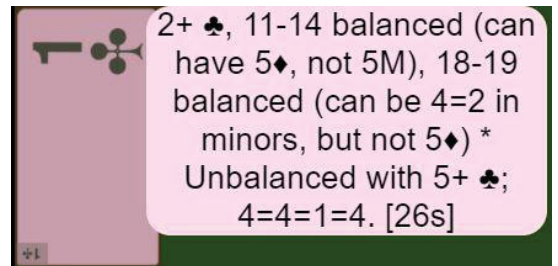

16. System

All teams are required to write a brief about their system at the table chat box before the start of first board in each match.

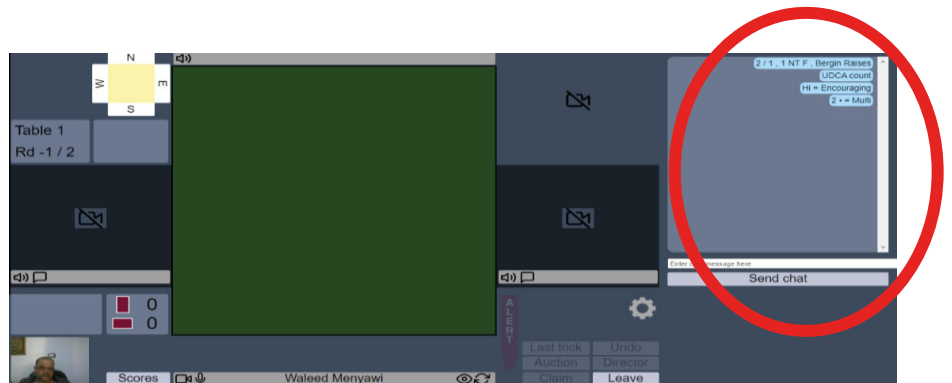



How to load your system card (convention card)

Step 1

Copy the link to your system card/convention card from where it is on the web, like this:

Team	Link to card	Added/Updated	Copy Link
CALEDONIA	CC Sam Pansch & Jen Middleton.pdf	18 Apr 2025 21:24	Copy Link
CALEDONIA	McQuaker-McGowan WBF 2025.pdf	8 Apr 2025 21:13	Copy Link
CALEDONIA	adamson online wbf Feb 2025.pdf	5 Apr 2025 17:08	Copy Link
CASTELLS	Hoja de convenciones Maria Mansilla- Laura Casavola 20240109.pdf	10 Apr 2025 11:07	Copy Link

- Find your card.
- Click the **Copy Link** button next to the system card name.

Step 2

When sitting at the table, click the System Card/Convention Card icon to the right of your grey name-band at the bottom of the window.

This box appears:



Step 3 Paste your system card/convention card link into the box. To paste the link:

- On Windows, right-click in the box. Then do **Paste**.
- On a Mac, hold down **Ctrl** and click in the box. Then do **Paste**.
- On an iPad, long-press in the box. Then do **Paste**.

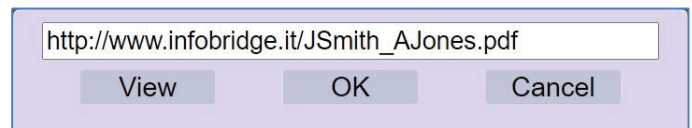
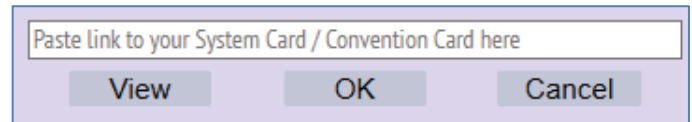

Click OK.

